

MAY 2019

BRETT MARTIN
UNDERGROUND SYSTEMS

PRODUCT GUIDE

PRODUCT RANGE
INSTALLATION DETAILS

UNDERGROUND SYSTEMS

UNDERGROUND



Plumbing & Drainage

P R O D U C T G U I D E



Plumbing & Drainage

Brett Martin is a multi-site international organisation producing not only an extensive range of plastic Underground, Rainwater and Plumbing systems but also Europe's largest range of GRP, PVC, Polycarbonate and Acrylic rooflight sheet products.

Our reputation for excellence in product quality and technical service is founded on over 60 years manufacturing experience.



BRETT MARTIN
PLUMBING &
DRAINAGE MANUALS

UNDERGROUND

PRODUCT GUIDE

Brett Martin Underground Drainage offers a comprehensive range of drainage systems. It includes the Drain, Sewer, Perforated, Surface Water and Cable Duct systems. The entire range incorporates pipes and fittings in fourteen diameters ranging from 53.9mm to 600mm.

When selecting a Brett Martin Underground Drainage System you can be sure that every product has been designed with ease of installation in mind to offer the installer maximum choice and flexibility.

All products are manufactured to exacting standards through the company's achievement of BS EN ISO 9001:2015. You can be confident that as a BSI registered firm our Quality Assurance Programme guarantees that each Brett Martin system is a first class product, ensuring the highest possible levels of performance.



PRODUCT CATALOGUE

INTRODUCTION

Page

6

STANDARDS & CERTIFICATIONS

7

PRODUCT INDEX

DRAIN & SEWER PIPES	8
PERFORATED PIPES	9
COUPLINGS, SOCKETS & SLEEVES	10
SINGLE SOCKET BENDS	11-12
DOUBLE SOCKET BENDS	12-13
LONG RADIUS BENDS	13
BRANCHES	14-16
CLIP SADDLE BRANCHES	17
ADAPTORS	18
PLUGS	19
WASTE ADAPTORS	19-20
BOTTLE GULLY RANGE	21-22
GULLY RANGE	22-23
HOPPERS	23-24
GRID/SEALING PLATES	24-25
SHALLOW ACCESS CHAMBERS	26-28
INSPECTION CHAMBERS	28-29
CHANNEL PIPES & BENDS	30-31
CHANNEL BENDS	32
ROAD GULLIES	33
ACCESS FITTINGS	33
TWINWALL PIPES & FITTINGS	34
CABLE DUCTS	35
STORMCRATE ATTENUATION & INFILTRATION	36
RINGS & SUNDRIES	36

TECHNICAL INFORMATION

FUNCTION	38
AUTHORITY	38
STANDARDS	38
COMPOSITION	38
BIOLOGICAL AND CHEMICAL RESISTANCE	38
GENERAL RESISTANCES	38

GENERAL INFORMATION

STORAGE	39
HANDLING	39
TRANSPORT	39

INSTALLATION

Page

INSTALLATION – GENERAL POINTS	40
FLOW PROPERTIES	40
CHOICE OF GRADIENTS	41
PIPE SIZING	41
FLOW PROPERTIES – CLEAN SEWERS	42
FLOW PROPERTIES – MATURE SEWERS	43
FLOW PROPERTIES – ROUGH BORE	44
SPECIAL PROTECTION – GROUND LOADS	45
TRENCH PREPARATION	45
MATERIALS FOR BEDDING	46
EASE OF COMPACTION	47
PIPE LAYING	47
SPECIAL PROTECTION – SETTLEMENT	48
SPECIAL PROTECTION – SURCHARGING	48
ACCESS TO DRAINS	49
PREFORMED INSPECTION CHAMBERS	50-51
SHALLOW ACCESS CHAMBERS	52
ACCESS AND INSPECTION CHAMBERS	53
OPEN CHANNEL MANHOLES	54
BACKDROP MANHOLE CONSTRUCTION	55
RODDING ACCESS	56
HEAD OF DRAIN RODDING POINT	56
UNIVERSAL RODDABLE BOTTLE GULLY	57
RODDING ACCESS	57
TYPICAL LAYOUT USING RODDING	
ACCESS COMPONENTS	57
TYPICAL INSTALLATION (ENGLAND & WALES)	58
TRADITIONAL GULLY ASSEMBLY	58
HORIZONTAL BACK INLET ASSEMBLY	59
BOTTLE GULLY ASSEMBLY	59
SOIL PIPE CONNECTION (SHORT RADIUS)	59
SOIL PIPE CONNECTION (LONG RADIUS)	60
RAINWATER PIPE CONNECTIONS	60
SADDLE BRANCH, BRANCH ENTRIES	60
PIPE JOINTS	61
CUTTING	61
PUSH-FIT JOINTING	61
PERFORATED PIPE	62
SOLVENT CEMENT JOINTING	63
CONNECTION TO UNDERGROUND DRAINAGE	64
MAINTENANCE	64
CHEMICAL RESISTANCES	65-67

PRODUCT CATALOGUE	Page
INTRODUCTION	6
STANDARDS & CERTIFICATIONS	7
PRODUCT INDEX	
DRAIN & SEWER PIPES	8
PERFORATED PIPES	9
COUPLINGS, SOCKETS & SLEEVES	10
SINGLE SOCKET BENDS	11-12
DOUBLE SOCKET BENDS	12-13
LONG RADIUS BENDS	13
BRANCHES	14-16
CLIP SADDLE BRANCHES	17
ADAPTORS	18
PLUGS	19
WASTE ADAPTORS	19-20
BOTTLE GULLY RANGE	21-22
GULLY RANGE	22-23
HOPPERS	23-24
GRID/SEALING PLATES	24-25
SHALLOW ACCESS CHAMBERS	26-28
INSPECTION CHAMBERS	28-29
CHANNEL PIPES & BENDS	30-31
CHANNEL BENDS	32
ROAD GULLIES	33
ACCESS FITTINGS	33
TWINWALL PIPES & FITTINGS	34
CABLE DUCTS	35
STORMCRATE ATTENUATION & INFILTRATION	36
RINGS & SUNDRIES	36

PRODUCT

INTRODUCTION

Brett Martin Drain and Sewer Systems are fully comprehensive ranges of underground drainage and sewerage systems.

Pipes and Fittings are produced in six (OD) diameters, ranging from 110mm to 400mm. Both 110mm and 160mm pipe ranges are available in both SN4 and SN8 stiffness classes. The systems are manufactured under BS EN ISO 9001:2015 certification and tested to the requirements of BS EN 13598-1 and BS EN 1401-1 and many items carry the BSI Kitemark.

Brett Martin also offers a range of standard or heavy duty perforated land drainage pipes available in fourteen diameters ranging from 53.9mm to 600mm. Each pipe is supplied with an integral blown socket, cutting installation time to a minimum. A popular section of the range, is the Brett Martin Cable Duct system, ranging from 53.9mm to 200mm diameter. A super smooth bore, push fit blown sockets and a comprehensive range of bends and couplers make the Brett Martin Duct system easy and efficient to assemble.

The Brett Martin Drain, Sewer, Surface Water and Cable Duct systems form part of the vast range of quality products manufactured for the construction industry, and are among the leading Underground Systems now available.

Brett Martin has an ongoing programme of investment. You can be confident of well designed products combining ease of installation with high levels of performance efficiency.

UNDERGROUND DRAINAGE PRODUCT GUIDE

The Brett Martin Underground Drainage Product Guide illustrates all the components which make up Brett Martin Underground Systems. Information relating to dimensions, performance, illustration, design and fitting are provided. The Brett Martin Underground Drainage Product Guide is a comprehensive manual for architect, specifier and builder alike.

AVAILABILITY

Brett Martin Underground Systems are available from builders' merchants throughout the UK and Ireland. There is a direct to site delivery service available.

CONDITIONS OF SALE

Brett Martin Underground Systems are sold subject to the Conditions of Sale, copies of which are available on request.

STANDARDS

Brett Martin Drainage systems are manufactured under the following British and European Standards:-

BS EN ISO 9001:2015 Quality Management Systems

BS EN 1401-1



Plastic piping systems for non-pressure underground drainage and sewerage. Unplasticized poly(vinyl chloride) (PVC-U). Part 1: Specifications for pipes, fittings and the system.

BS EN 13598-1:2010



Plastics piping systems for non-pressure underground drainage and sewerage. Unplasticized poly(vinyl chloride) (PVC-U), polypropylene (PP) and polyethylene (PE). Part 1: Specifications for ancillary fittings including shallow inspection chambers.

PRODUCT CERTIFICATIONS

The following Brett Martin Underground products have full BBA accreditation:

BBA 87/1898
Product Sheet 1



110 mm Diameter PVC-U Surface Water Drainage Pipe and 110 mm and 160 mm Diameter Polypropylene Pipe Couplings, for use with pipe and fittings complying with BS EN 1401 :2009, underground for the conveyance of surface water.

BBA 87/1898
Product Sheet 2



110mm Diameter PVC-U Drainage Pipe for use with pipe and fittings complying with BS EN 1401.

BBA 10/H168



Twinwall Drainage Fittings, for use in highway drainage in conjunction with BBA-certificated polyethylene twinwall highway drainage pipes (nominal sizes: 150 mm, 225 mm and 300 mm) and associated seals.

INSTALLATION STANDARDS

Drain and Sewer installations must be designed to comply with the following:

- The Building Regulations 2010, Approved Document H, Section H1
- Building (Scotland) Regulations 2004, Technical Handbook (Domestic & Non-Domestic) Section 3: Environment
- Building Regulations (Northern Ireland) 2012, Technical Booklet N, Section 3
- Building Regulations 2010, Technical Guidance Document H, Section 1.3 (ROI)
- Sewers for Adoption 7 (SfA7), Flexible (Plastic) Deep Inspection Chamber for adoptable installation down to 3m for a Type 3 installation and 2m for a Type 4 installation.

Comprehensive guidance on the design of drain and sewer systems is given in BS EN 752:2017 and BS5955: Part 6: 1980 Code of Practice for the Installation of Unplasticized PVC pipework for Gravity Drains and Sewers.

Following the recommendations of these codes is also deemed necessary to satisfy the requirements of the above Building Regulations.

All information in this Product Guide is based on the above documents, which should in any case be consulted for all installations.

PIPE - PLAIN ENDED 

CODE	SIZE	LENGTH	WALL THICKNESS
B4001	110mm	3m	3.2mm
B4011	110mm	6m	3.2mm
B6001	160mm	3m	4.1mm
B6011	160mm	6m	4.1mm
B6001 SN8	160mm	3m	4.7mm
B6011 SN8	160mm	6m	4.7mm
B20300	200mm	3m	4.9mm
B20600	200mm	6m	4.9mm
B25300	250mm	3m	6.1mm
B25600	250mm	6m	6.1mm
B31300	315mm	3m	7.7mm
B31600	315mm	6m	7.7mm
B40300	400mm	3m	9.8mm
B40600	400mm	6m	9.8mm

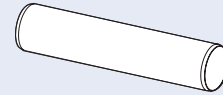
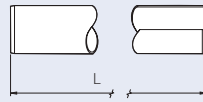

PIPE - SINGLE SOCKET 

CODE	SIZE	LENGTH	Y (Socket Length)
B4403	110mm	3m	70mm
B4406	110mm	6m	70mm
B6603	160mm	3m	95mm
B6606	160mm	6m	95mm
B6603 SN8	160mm	3m	95mm
B6606 SN8	160mm	6m	95mm
B20003	200mm	3m	110mm
B20006	200mm	6m	110mm
B25003	250mm	3m	140mm
B25006	250mm	6m	140mm
B31003	315mm	3m	155mm
B31006	315mm	6m	155mm
B40003	400mm	3m	215mm
B40006	400mm	6m	215mm

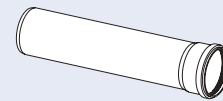
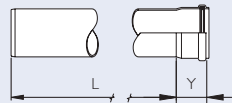

PIPE - SINGLE SOCKET

CODE	SIZE	LENGTH	Y (Socket Length)
B4416	110mm	6m	70mm

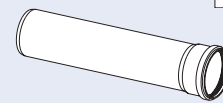
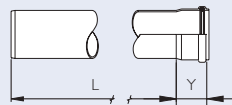

SURFACE WATER PIPE - PLAIN ENDED

CODE	SIZE	LENGTH
B4121	110mm	6m
B6121	160mm	6m

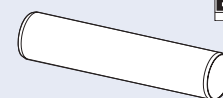
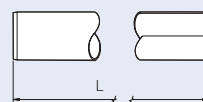

Manufactured in red oxide

SURFACE WATER PIPE- SOCKETED

CODE	SIZE	LENGTH	Y (Socket Length)
B4122	110mm	6m	70mm
B6122	160mm	6m	95mm

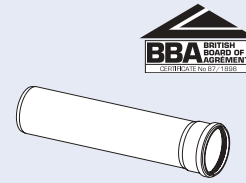
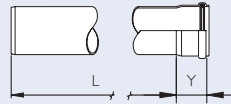

Manufactured in red oxide

**PERFORATED PIPE - BLOWN SOCKET
(PIPE TO BS 4660 / BS 5481)**

CODE	SIZE	LENGTH	WALL THICKNESS	HOLES PER M	°	Ø
B4023	110mm	6m	3.2mm	39	46°	6mm
B6023	160mm	6m	4.1mm	52	36°	6mm
B8023	200mm	6m	4.9mm	65	23°	6mm
B40610	400mm	6m	9.8mm	65	18°	8mm

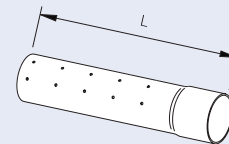

PERFORATED PIPE - SINGLE SOCKET

CODE	SIZE	LENGTH	WALL THICKNESS	HOLES PER M	°	Ø
B4123	110mm	6m	2.2mm	39	46°	6mm

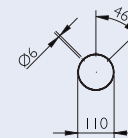

Note: UK codes B8023 and B40610 do not have a seal.

POLYPROPYLENE PIPE COUPLER

CODE	SIZE	LENGTH
B4021	110mm	95mm
B6021	160mm	130mm

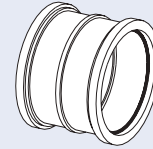
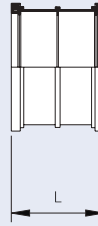

PVC (BS) COUPLER ♡

CODE	SIZE	LENGTH
B5001	110mm	135mm
B7001	160mm	175mm
B20021	200mm	225mm
B25021	250mm	265mm
B31021	315mm	300mm
B40021	400mm	370mm

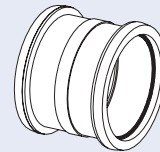
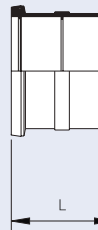

PVC (SLIP) COUPLER ♡

CODE	SIZE	LENGTH
B5001/S	110mm	135mm
B7001/S	160mm	175mm
B20022	200mm	225mm
B25022	250mm	270mm
B31022	315mm	310mm
B40022	400mm	560mm

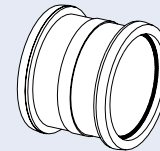
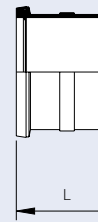

SINGLE SOCKET COUPLER ♡

CODE	SIZE	LENGTH
B5011	110mm	105mm
B7011	160mm	165mm

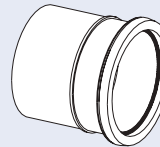

SINGLE SOCKET BEND 87 1/2° 

CODE	SIZE	X	Y
B5041	110mm	163mm	150mm
B7041	160mm	223mm	230mm
B20870	200mm	535mm	535mm
B25870	250mm	609mm	695mm
B31870	315mm	458mm	453mm
B40870	400mm	750mm	765mm

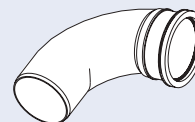
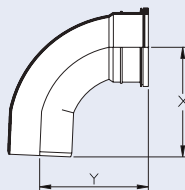

SINGLE SOCKET BEND 67 1/2° 

CODE	SIZE	X	Y
B5051	110mm	128mm	169mm
B7051	160mm	183mm	235mm

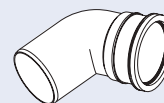
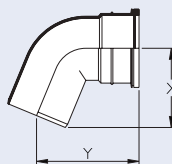

SINGLE SOCKET BEND 45° 

CODE	SIZE	X	Y
B5061	110mm	96mm	142mm
B7061	160mm	138mm	228mm
B20450	200mm	370mm	610mm
B25450	250mm	224mm	407mm
B31450	315mm	300mm	495mm
B40450	400mm	570mm	880mm

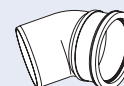
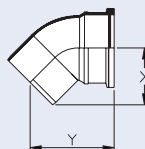

SINGLE SOCKET BEND 30° 

CODE	SIZE	X	Y
B20030	200mm	116mm	285mm
B25030	250mm	235mm	511mm
B31030	315mm	284mm	628mm
B40030	400mm	495mm	740mm

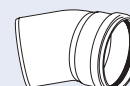
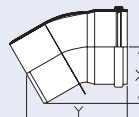

SINGLE SOCKET BEND 22 1/2° 

CODE	SIZE	X	Y
B5071	110mm	78mm	149mm
B7171	160mm	113mm	234mm

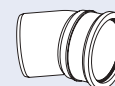
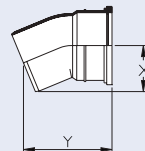

SINGLE SOCKET BEND 15° 

CODE	SIZE	X	Y
B20015	200mm	132mm	250mm
B25015	250mm	150mm	320mm
B31015	315mm	230mm	470mm
B40015	400mm	260mm	700mm

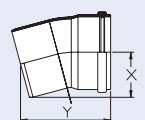

SINGLE SOCKET BEND 11 1/4° 

CODE	SIZE	X	Y
B5081	110mm	68mm	144mm
B7181	160mm	103mm	219mm

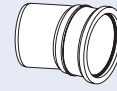
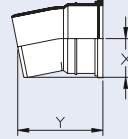

SINGLE SOCKET BEND 0° - 30° ADJUSTABLE

CODE	SIZE	X	Y
B5030	110mm	90mm	178mm

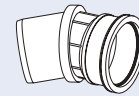
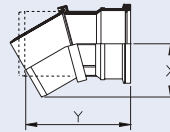

DOUBLE SOCKET REST BEND 87 1/2° (LONG RADIUS) 

CODE	SIZE	X	Y
B4131	110mm	241mm	263mm

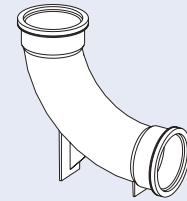
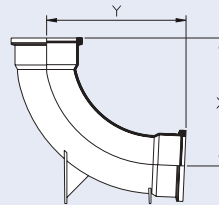

DOUBLE SOCKET BEND 87 1/2° 

CODE	SIZE	X	Y
B4031	110mm	156mm	150mm
B6031	160mm	223mm	228mm

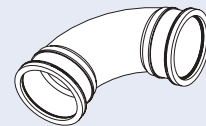
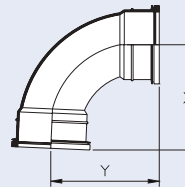

DOUBLE SOCKET BEND 67 1/2° 

CODE	SIZE	X	Y
B4071	110mm	143mm	173mm
B6071	160mm	187mm	228mm

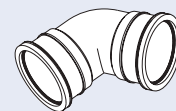
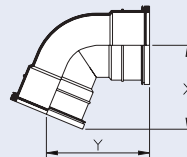

DOUBLE SOCKET BEND 45° 

CODE	SIZE	X	Y
B4041	110mm	104mm	143mm
B6041	160mm	163mm	231mm

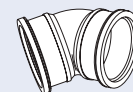
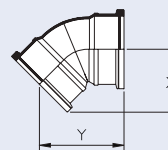

DOUBLE SOCKET BENDS LONG RADIUS BENDS (PLAIN ENDED AND SINGLE SOCKETED)

DOUBLE SOCKET BEND 22 1/2°

CODE	SIZE	X	Y
B4051	110mm	88mm	149mm
B6051	160mm	133mm	227mm

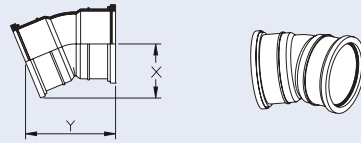

DOUBLE SOCKET BEND 11 1/4°

CODE	SIZE	X	Y
B4061	110mm	78mm	147mm
B6061	160mm	123mm	221mm

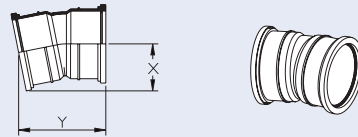

DOUBLE SOCKET BEND 0°- 30° ADJUSTABLE BEND

CODE	SIZE	X	Y
B4030	110mm	104mm	181mm

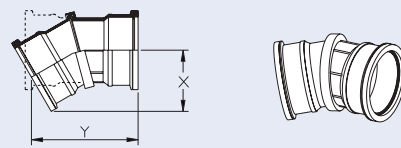

LONG RADIUS BEND 87 1/2°

CODE P/E	CODE S/S	SIZE	RADIUS
B5031	5930	110mm	400mm
B7021	7921	160mm	610mm

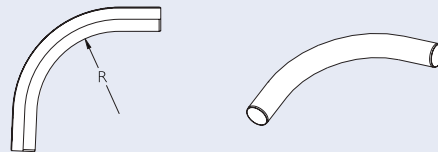

Plain-ended version shown

LONG RADIUS BEND 45°

CODE P/E	CODE S/S	SIZE	RADIUS
B5032	5931	110mm	400mm
B7022	7922	160mm	610mm

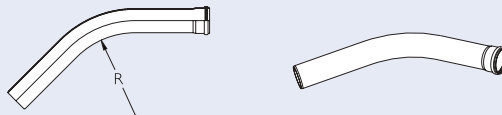

Single-socketed version shown

LONG RADIUS BEND 22 1/2°

CODE P/E	CODE S/S	SIZE	RADIUS
B5033	5932	110mm	400mm
B7023	7923	160mm	610mm

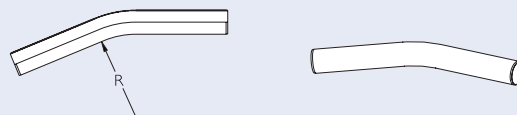

Plain-ended version shown

LONG RADIUS BEND 11 1/4°

CODE P/E	CODE S/S	SIZE	RADIUS
B5034	5933	110mm	400mm
B7024	7924	160mm	610mm

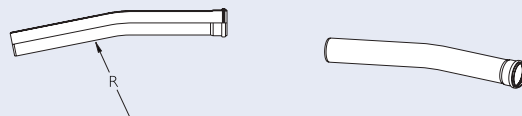

Single-socketed version shown

110mm 87½° TRIPLE SOCKET BRANCH 

CODE	SIZE	X	Y
B4081	110mm X 110mm dia.	135mm	145mm
B7092	160mm X 110mm dia.	223mm	228mm

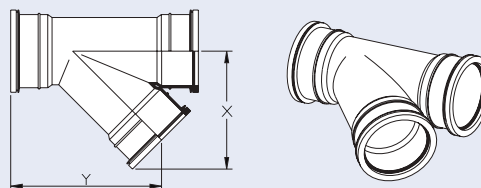

160mm 87½° TRIPLE SOCKET BRANCH 

CODE	SIZE	X	Y
B6081	160mm X 160mm dia.	223mm	228mm

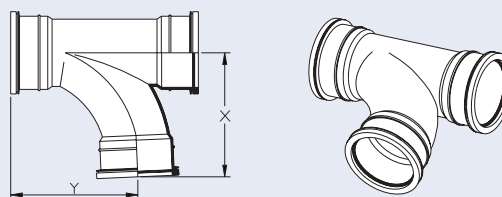

110mm 45° TRIPLE SOCKET BRANCH 

CODE	SIZE	X	Y
B4091	110mm X 110mm dia.	188mm	244mm
B7102	160mm X 110mm dia.	223mm	300mm

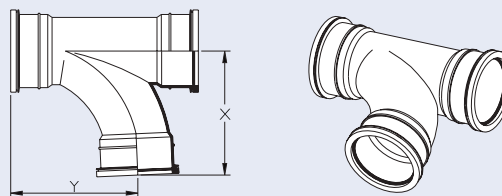

160mm 45° TRIPLE SOCKET BRANCH 

CODE	SIZE	X	Y
B6091	160mm X 160mm dia.	298mm	333mm

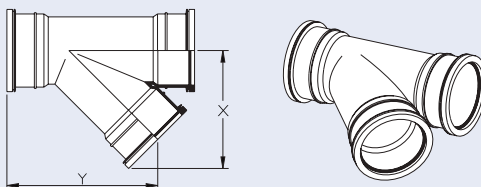

110mm 87½° DOUBLE SOCKET BRANCH 

CODE	SIZE	X	Y
B5101	110mm X 110mm dia.	135mm	150mm
B7091	160mm X 110mm dia.	223mm	223mm
B20118	200mm X 110mm dia.	240mm	380mm
B25118	250mm X 110mm dia.	250mm	325mm
B31118	315mm X 110mm dia.	310mm	370mm
B40118*	400mm X 110mm dia.	345mm	465mm

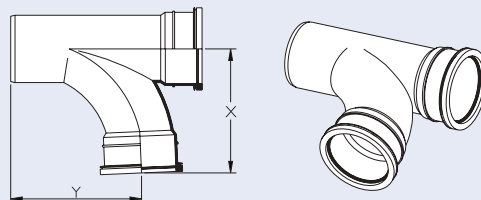

160mm 87½° DOUBLE SOCKET BRANCH 

CODE	SIZE	X	Y
B7111	160mm X 160mm dia.	223mm	224mm
B20168	200mm X 160mm dia.	305mm	310mm
B25168	250mm X 160mm dia.	310mm	365mm
B31168	315mm X 160mm dia.	363mm	427mm
B40168*	400mm X 160mm dia.	405mm	485mm

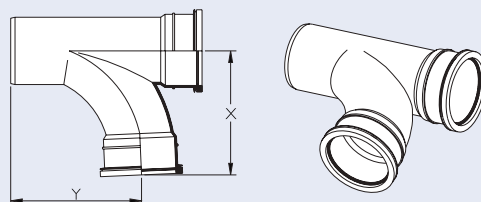

*Not kitemarked

200mm 87 1/2° DOUBLE SOCKET BRANCH 

CODE	SIZE	X	Y
B20208	200mm X 200mm dia.	395mm	405mm
B25208	250mm X 200mm dia.	460mm	470mm
B31208	315mm X 200mm dia.	400mm	475mm
B40208*	400mm X 200mm dia.	440mm	475mm

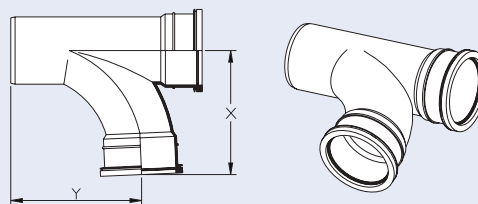

250mm 87 1/2° DOUBLE SOCKET BRANCH 

CODE	SIZE	X	Y
B25258	250mm X 250mm dia.	445mm	453mm
B31258	315mm X 250mm dia.	490mm	550mm
B40258*	400mm X 250mm dia.	565mm	720mm

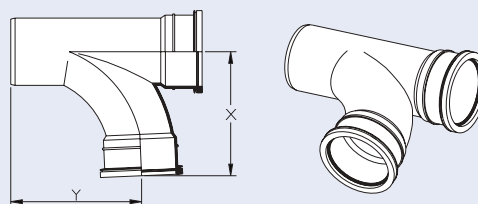

315mm 87 1/2° DOUBLE SOCKET BRANCH 

CODE	SIZE	X	Y
B31318	315mm X 315mm dia.	570mm	670mm
B40318*	400mm X 315mm dia.	710mm	720mm

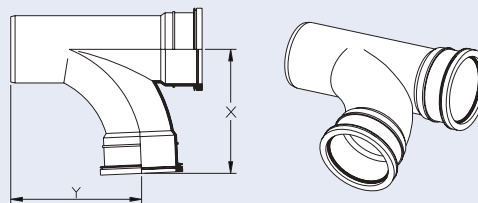

400mm 87 1/2° DOUBLE SOCKET BRANCH

CODE	SIZE	X	Y
B40408	400mm X 400mm dia.	725mm	645mm

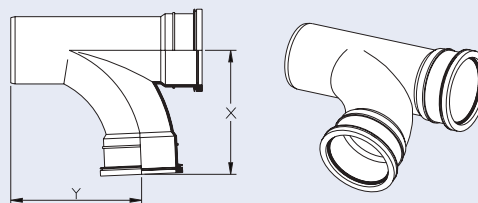

110mm 45° DOUBLE SOCKET BRANCH 

CODE	SIZE	X	Y
B5111	110mm X 110mm dia.	188mm	252mm
B7101	160mm X 110mm dia.	223mm	296mm
B20110	200mm X 110mm dia.	227mm	285mm
B25110	250mm X 110mm dia.	269mm	380mm
B31110	315mm X 110mm dia.	315mm	432mm
B40110*	400mm X 110mm dia.	345mm	560mm

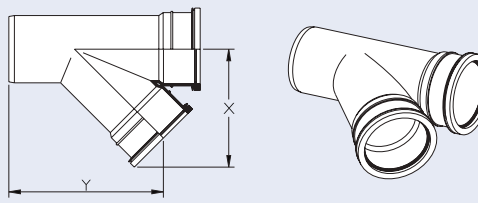

160mm 45° DOUBLE SOCKET BRANCH 

CODE	SIZE	X	Y
B7121	160mm X 160mm dia.	298mm	329mm
B20160	200mm X 160mm dia.	287mm	355mm
B25160	250mm X 160mm dia.	349mm	440mm
B31160	315mm X 160mm dia.	340mm	482mm
B40160	400mm X 160mm dia.	410mm	575mm

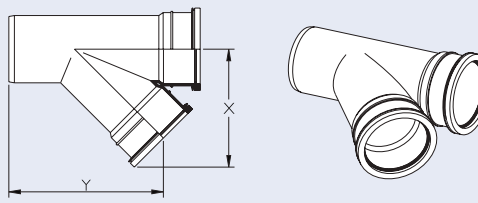

*Not kitemarked

200mm 45° DOUBLE SOCKET BRANCH 

CODE	SIZE	X	Y
B20200	200mm X 200mm dia.	307mm	405mm
B25200	250mm X 200mm dia.	389mm	435mm
B31200	315mm X 200mm dia.	360mm	525mm
B40200	400mm X 200mm dia.	420mm	550mm

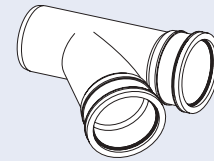
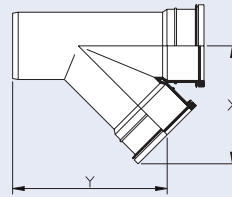

250mm 45° DOUBLE SOCKET BRANCH 

CODE	SIZE	X	Y
B25250	250mm X 250mm dia.	459mm	540mm
B31250	315mm X 250mm dia.	445mm	617mm
B40250*	400mm X 250mm dia.	500mm	750mm

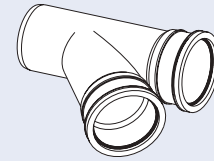
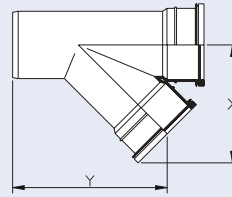

315mm 45° DOUBLE SOCKET BRANCH 

CODE	SIZE	X	Y
B31315	315mm X 315mm dia.	480mm	760mm
B40315*	400mm X 315mm dia.	550mm	800mm

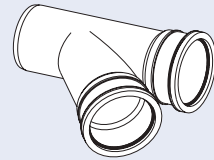
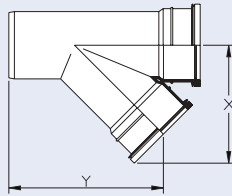

400mm 45° DOUBLE SOCKET BRANCH 

CODE	SIZE	X	Y
B40400*	400mm X 400mm dia.	600mm	850mm

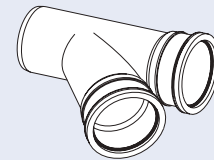
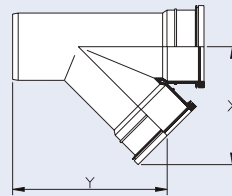

*Not kitemarked

SOLVENT WELD 87 1/2° 

CODE	SIZE	LENGTH
B7007	110mm X 110mm dia.	200mm
B7008	160mm X 110mm dia.	305mm
B7009	160mm X 160mm dia.	305mm

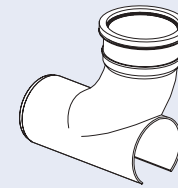
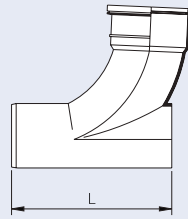

SOLVENT WELD 45° 

CODE	SIZE	LENGTH
B7002	110mm X 110mm dia.	245mm
B7003	160mm X 110mm dia.	325mm
B7004	160mm X 160mm dia.	325mm

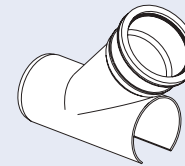
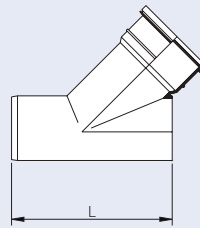

The following Clip Saddle Branches are available on request

	200mm	250mm	315mm	400mm
Solvent 90° - Dia Branch 110mm	B20111	B25111	B31111	B40111
Solvent 90° - Dia Branch 160mm	B20161	B25161	B31161	B40161
Solvent 90° - Dia Branch 200mm	B20120	B25120	B31120	B40120
Solvent 90° - Dia Branch 250mm		B25125	B31125	B40125
Solvent 90° - Dia Branch 315mm				B40135
Solvent 90° - Dia Branch 400mm				B40140

SALT GLAZE SOCKET ADAPTOR

CODE	SIZE	X
B5131	110mm	115mm
B7161	160mm	200mm
B20108	200mm	210mm
B25108	250mm	570mm
B31108	315mm	570mm
B40108	400mm	640mm

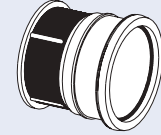
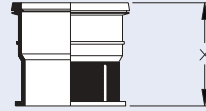

SALT GLAZE SPIGOT ADAPTOR

CODE	SIZE	X	Y
B5141	110mm	150mm	80mm
B7151	160mm	170mm	115mm
B20109	200mm	250mm	155mm
B25109	250mm	600mm	155mm
B31109	315mm	600mm	195mm
B40109	400mm	800mm	260mm

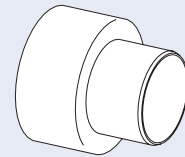
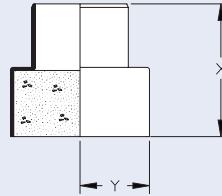

PVCu TO STANDARD CLAY ADAPTOR

CODE	SIZE	X	Y
B3500	110mm	135mm	165mm

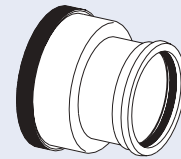
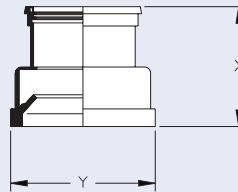

PVCu TO SUPER CLAY ADAPTOR

CODE	SIZE	X	Y
B3510	110mm	135mm	165mm

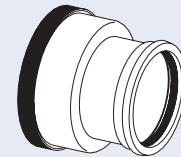
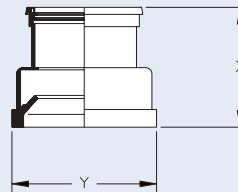

LEVEL INVERT TAPER (Reduces to next diameter down) ♡

CODE	SIZE	X
B7131	110mm X 160mm	185mm
B20112	160mm X 200mm	250mm
B25113	200mm X 250mm	310mm
B31114	250mm X 315mm	360mm
B40115	315mm X 400mm	470mm

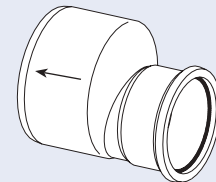
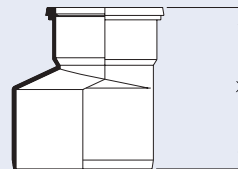

Puddle Flange 160mm code B7191 available on request

TEMPORARY PIPE PLUG

CODE	SIZE	LENGTH
B5120	110mm	71mm

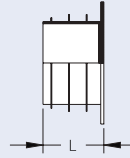

PERMANENT PIPE PLUG

CODE	SIZE	LENGTH
B5122	110mm	71mm

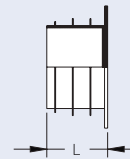

SOCKET PLUG 

CODE	SIZE	LENGTH
B5121	110mm	70mm
B7141	160mm	69mm
B20141	200mm	105mm
B25141	250mm	135mm
B31141	315mm	152mm
B40141	400mm	270mm

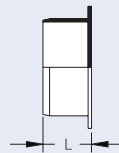

PUSH-FIT WASTE ADAPTOR

CODE	SIZE
B4101	32mm
B4201	40mm
B4301	50mm

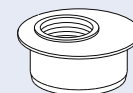

50mm SOLVENT WELD WASTE ADAPTOR

CODE	SIZE
B4501	76mm

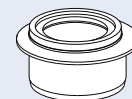

32mm X 32mm SOLVENT WELD WASTE ADAPTOR

CODE	SIZE
B4601	32mm X 32mm

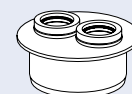
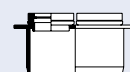

32mm X 40mm SOLVENT WELD WASTE ADAPTOR

CODE SIZE
B4701 32mm X 40mm

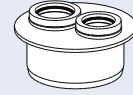
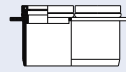

110mm TO 68mm RAINWATER ADAPTOR

CODE A B C D E
BR223B 139mm 110mm 43mm 40mm 68mm

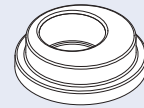
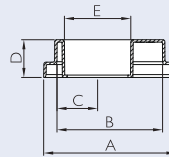

(Can be used to connect to both pipe spigot and a fitting socket. Available in Black only. For 65mm Square pipe, also use code BR517)

UNIVERSAL ADAPTOR (PIPE)

(Use rainwater adaptor to BR517 to connect to square pipe)

CODE SIZE
B4801 110mm

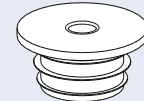
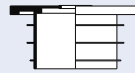

UNIVERSAL ADAPTOR (SOCKET) ♡

CODE SIZE
B4901 110mm

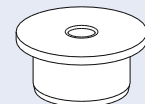

BACK INLET RODDABLE GULLY 90° OUTLET ROUND GRID

CODE	SIZE	X	Y	Z
B1001	110mm	286mm	151mm	250mm

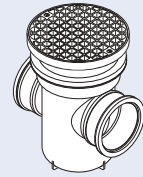
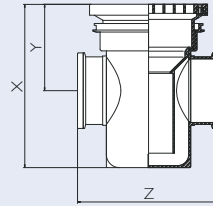

BACK INLET RODDABLE GULLY 90° OUTLET RECTANGULAR GRID

(pedestrian areas only)

CODE	SIZE	X	Y	Z
B1002	110mm	308mm	173mm	250mm

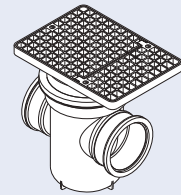
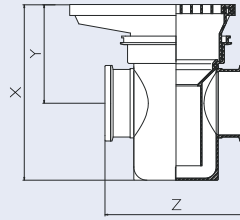

BACK INLET RODDABLE GULLY 90° OUTLET SQUARE GRID

(pedestrian areas only)

CODE	SIZE	X	Y	Z
B1003	110mm	348mm	212mm	250mm

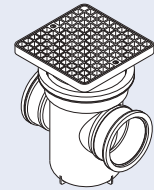
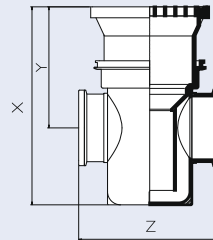

SPARE ROUND HOPPER AND GRID

CODE	SIZE	X	Y
B1004	110mm	207mm	78mm

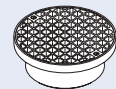
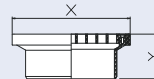

SPARE RECTANGULAR HOPPER AND GRID

(pedestrian areas only)

CODE	SIZE	X	Y
B1005	110mm	290mm	100mm

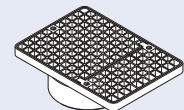
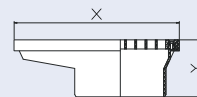

SPARE SQUARE HOPPER AND GRID

CODE	X	Y	Z
B1006	207mm	139mm	160mm

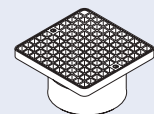
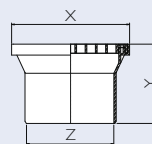

RAISING PIECE FOR BACK INLET GULLY

CODE	SIZE	X
B1007	110mm	200mm

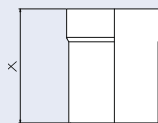

PAVING COLLAR

(Use with Square Hopper - code I006)

CODE	SIZE	X	Y
B1008	110mm	304mm	90mm

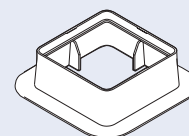
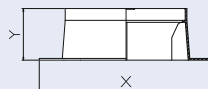

SPARE RUBBER RING

CODE	SIZE
B1043	110mm



ROUND TO SQUARE ADAPTOR

CODE	SIZE
B1042	200mm

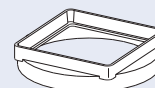

300mm X 600mm TRAPPED YARD GULLY

CODE	SIZE	X	Y
B6300	110mm	300mm	600mm

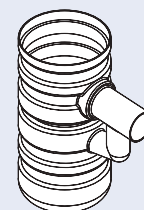

ALUMINIUM SILT BUCKET

CODE	SIZE
B6301	110mm

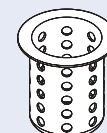

HEAVY DUTY GRATING TO BS EN 124 CLASS C250kN

CODE	SIZE
B6302	110mm

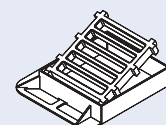

GULLY RANGE HOPPERS (including Grid)

LOW TRAPPED GULLY

CODE	SIZE	X	Y
B1013	110mm	213mm	218mm

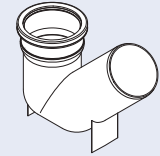
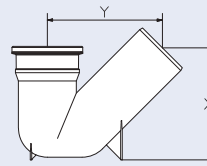

P SOCKET LOW TRAPPED GULLY

CODE	SIZE	X	Y
B1301	110mm	235mm	330mm

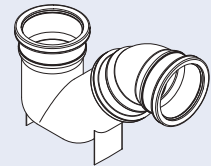
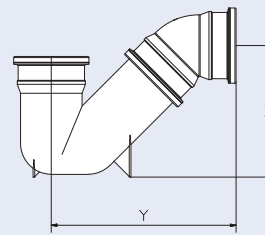

INTEGRAL RECTANGULAR HOPPER

CODE	SIZE	X	Y	Z
B1031	110mm	225mm	275mm	125mm

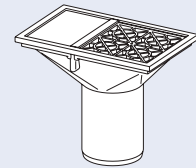
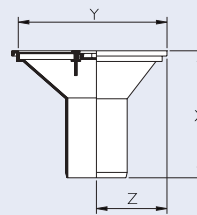

ROUND HOPPER (200mm x 110mm)

CODE	SIZE	X	Y	Z
B1021	110mm	245mm	215mm	107.5mm

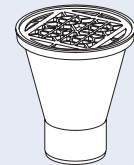
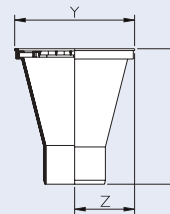

SQUARE HOPPER (160mm X 110mm)

CODE	SIZE	X	Y	Z
B1071	110mm	240mm	160mm	80mm

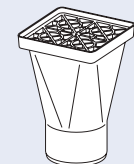
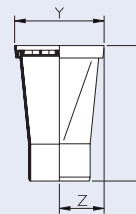

HOPPERS (including Grid) HOPPERS (with Horizontal Socket Inlet)

SQUARE HOPPER (160mm X 160mm) WITH 110mm SOLVENT SOCKET

CODE	SIZE	X	Y
B1061	110mm	104mm	160mm

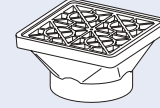
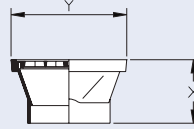

SQUARE HOPPER RISER

CODE	SIZE	X	Y
B1078	110mm	150mm	80mm

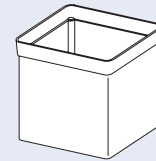
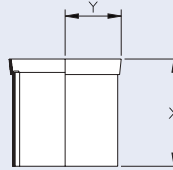

I INLET ROUND HOPPER (200mm with 110mm Inlet)

CODE	SIZE
B1022	110mm

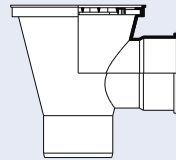

I INLET SQUARE HOPPER (160mm with 110mm Inlet)

CODE	SIZE
B1077	110mm

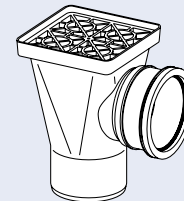
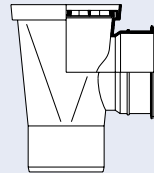

DISHED GRATE - ALLOY SQUARE

CODE	X	Y
B9131	160mm	160mm

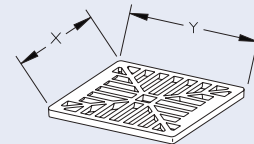

DISHED GRATE - PLASTIC SQUARE

CODE	X	Y
B9141	160mm	160mm

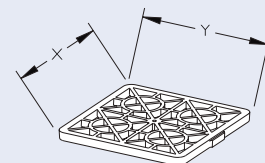

HINGED - ALLOY SQUARE

CODE	X	Y
B6666	150mm	150mm

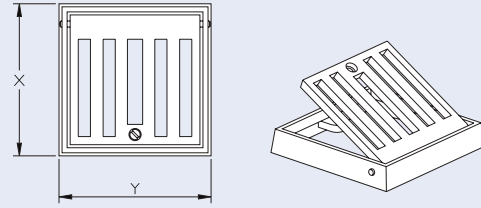

Approved by the NI Housing Executive

ROUND ALLOY

CODE	DIAMETER (d)
B9151	200mm

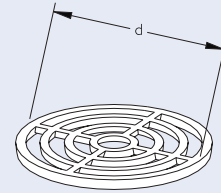

ROUND PLASTIC

CODE	DIAMETER (d)
B9171	200mm

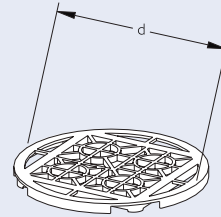

SEALING PLATE - SQUARE DIE CAST ALLOY

CODE	X	Y
B9201	160mm	160mm

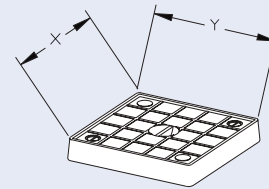

SEALING PLATE - ROUND DIE CAST ALLOY

CODE	DIAMETER (d)
B9221	200mm

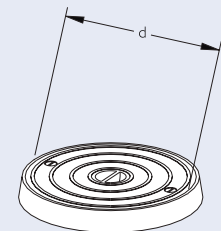

Additional items available on request
Bars For Integral Hopper Code B1034
Plate For Integral Hopper Code B1035

SHALLOW ACCESS CHAMBERS (Adoptable & Non-adoptable)

280mm dia CHAMBER BASE

205mm INVERT (inc. 2 SOCKET PLUGS)

CODE	SIZE	DIAMETER (d)	Y
B2800	110mm	280mm	392mm

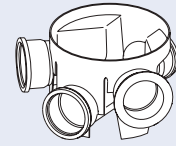
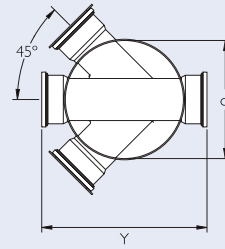

280mm dia 90° CHAMBER BASE (205mm INVERT)

CODE	SIZE	DIAMETER (d)	Y
B2803	110mm	280mm	305mm

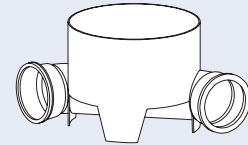
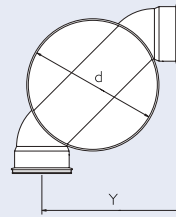

280mm dia SHALLOW ACCESS CHAMBER 185mm RISER

CODE	SIZE	DIAMETER (d)	INVERT (i)
B2801	110mm	266mm	185mm

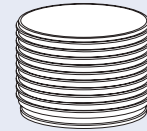
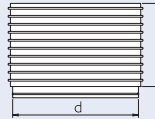

280mm dia SHALLOW ACCESS CHAMBER SQUARE DOUBLE SEAL LID (Black PVCu)

(For Pedestrian Areas Only)

CODE	SIZE	DIAMETER (d)
B2802	110mm	266mm

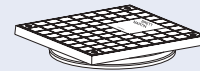
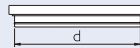

At installation, we recommend that a copper impregnated grease should be applied to the threads of the lid retaining screws for ease of removal.

(SfA7) ADOPTABLE 315mm SHALLOW ACCESS CHAMBER BASE (inc 2 socket plugs) EN 13598-1

CODE	SIZE	DIAMETER (d)	INVERT (i)
B3156	110mm	315mm	190mm

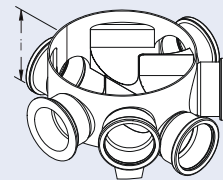
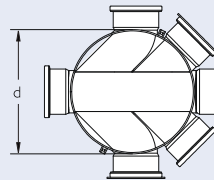

(SfA7) ADOPTABLE 315mm SHALLOW ACCESS CHAMBER RISER EN 13598-1

CODE	DIAMETER (d)	INVERT (i)
B3157	315mm	185mm

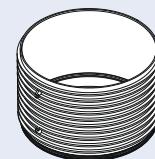
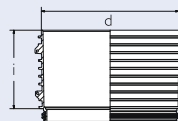

SHALLOW ACCESS CHAMBERS (Adoptable & Non-adoptable)

(SfA7) ADOPTABLE 315mm SHALLOW ACCESS CHAMBER SEAL EN 13598-1 (replacement seal for B3157)

CODE	DIAMETER (d)
B3158	315mm

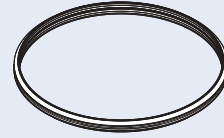

315mm dia. SHALLOW ACCESS CHAMBER BASE 190mm INVERT (inc. 2 Socket Plugs)

CODE	SIZE	DIAMETER (d)	INVERT (i)
B3150	110mm	315mm	190mm

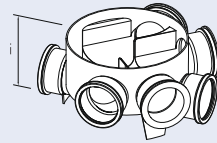
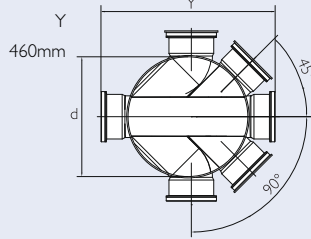

315mm dia SHALLOW ACCESS CHAMBER RISER 185mm INVERT

CODE	SIZE	DIAMETER (d)	INVERT (i)
B3151	110mm	315mm	185mm

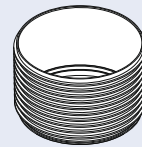
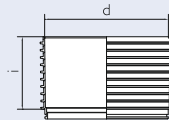

315mm dia. SHALLOW ACCESS CHAMBER SEALED LID (PEDESTRIAN) Black PVCu

CODE	SIZE	DIAMETER (d)	Y
B3153	110mm	315mm	330mm

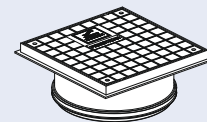
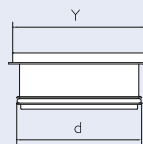

315mm dia. SHALLOW ACCESS CHAMBER SEALED LID (DRIVEWAY 35kN) Black PVCu

CODE	SIZE	DIAMETER (d)	Y
B3154	110mm	315mm	330mm

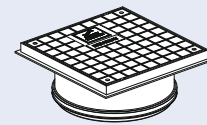
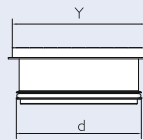

(SfA7) ADOPTABLE 450mm x 110mm INSPECTION CHAMBER BASE (inc 3 socket plugs) EN 13598-1

CODE	SIZE	DIAMETER (d)	INVERT (i)
B4500	110mm	450mm	225mm

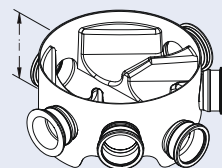
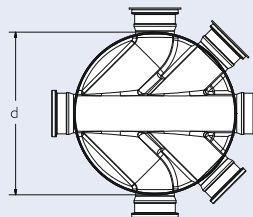

SHALLOW ACCESS CHAMBERS, INSPECTION CHAMBERS (Adoptable & Non-adoptable)

(SfA7) ADOPTABLE 450mm x 160mm INSPECTION CHAMBER BASE (inc 3 socket plugs) EN 13598-1

CODE	SIZE	INVERT (i)
B4506	160mm	255mm

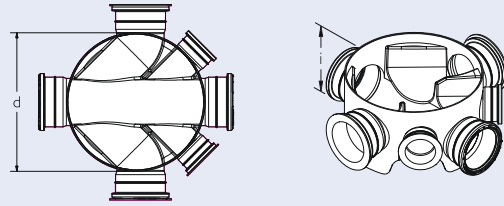

(SfA7) ADOPTABLE 450mm INSPECTION CHAMBER RISER EN 13598-1

CODE	DIAMETER (d)	INVERT (i)
B4502	450mm	300mm

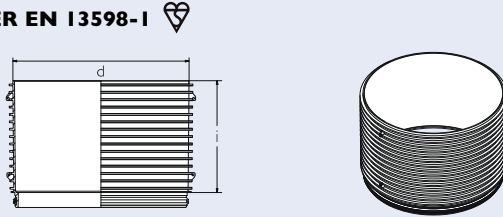

(SfA7) ADOPTABLE 450mm INSPECTION CHAMBER SEAL to EN 13598-1 (replacement seal for B4502)

CODE	DIAMETER (d)
B4503	450mm



450mm dia INSPECTION CHAMBER BASE (inc. 3 Socket Plugs)

CODE	SIZE	INVERT (i)	DIAMETER (d)
B5494	110mm	225mm	450mm

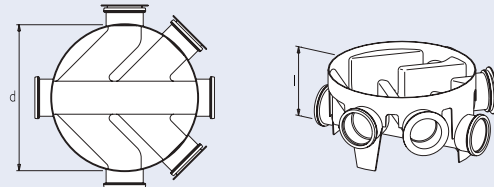

450mm dia INSPECTION CHAMBER BASE (inc. 3 Socket Plugs)

CODE	SIZE	INVERT (i)	DIAMETER (d)
B5696	160mm	255mm	450mm

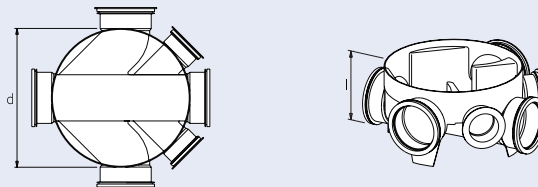

450mm dia CHAMBER RISER

CODE	INVERT (i)	DIAMETER (d)
B5397	315mm	450mm

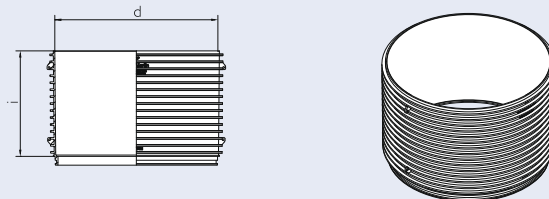

450mm SEALING RING – FOR USE WITH CODE B5397

(optional for where sealed chamber sections are required)

CODE	DIAMETER (d)
B5398	450mm

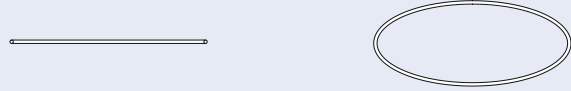

SECURED PLASTIC COVER AND FRAME TO EN124 A15 50KN

(suitable for domestic driveways)

CODE	Y	DIAMETER (d)
B6255	518mm	450mm

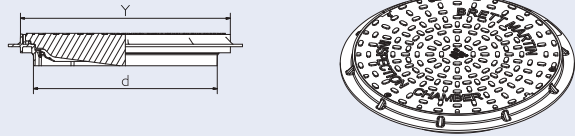

SECURED SQUARE PLASTIC COVER AND FRAME TO EN124 A15 50KN

(suitable for domestic driveways)

CODE	Y	DIAMETER (d)
B6260	545mm	450mm

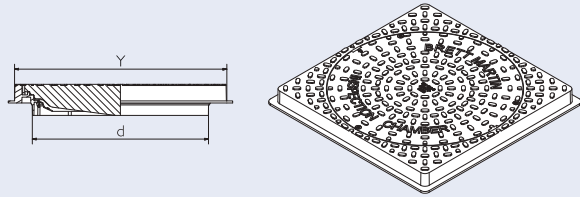

450mm X 350mm REDUCER - USE WHEN CHAMBER INVERT IS BETWEEN 1.2 AND 3mtrs

CODE	SIZE
B6350	450mm X 350mm

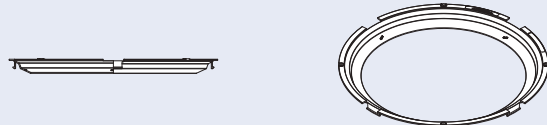

SPARE SOCKET PLUG

CODE	SIZE
B5000	110mm
B5100	160mm

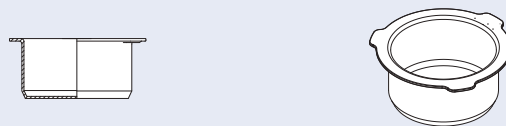

Long Radius Channel Bends in GB are sold without the lip.

CHANNEL PIPE PLAIN ENDED

CODE	SIZE	Y	LENGTH
B2281	110mm	600mm	1.5m
B2291	110mm	900mm	2.0m
B3001	160mm	600mm	1.5m
B3011	160mm	900mm	2.0m

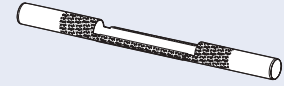
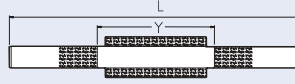

CHANNEL PIPE PLAIN ENDED - "LIPPED & CHIPPED"

(DOE (NI) Approved Cert. No P/OL/WSC 5.3.91)

CODE	SIZE	Y	LENGTH
B20123	200mm	600mm	1.5m
B25123	250mm	900mm	2.0m
B31123	315mm	600mm	1.5m
B40123	400mm	900mm	2.0m

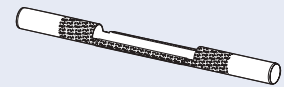
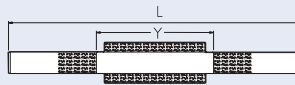

CHANNEL CONNECTOR

CODE	SIZE	X	Y
B2301	110mm	600mm	300mm
B3021	160mm	600mm	300mm

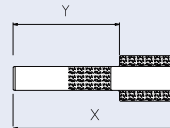

CHANNEL TAPER

CODE	SIZE	X
B3351	160mm X 110mm	180mm

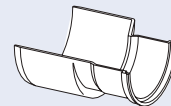
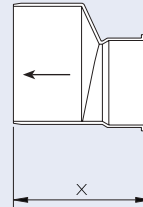

87 1/2° LONG RADIUS PLAIN END CHANNEL BEND

CODE	SIZE	RADIUS
B2531	110mm	450mm
B3331	160mm	940mm

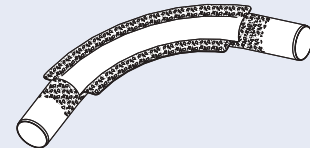
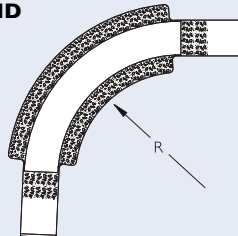

87 1/2° PLAIN END CHANNEL BEND "LIPPED & CHIPPED"

(DOE (NI) Approved Cert. No P/OL/WSC 5.3.91)

CODE	SIZE	RADIUS
B20901	200mm	940mm
B25901	250mm	940mm
B31901	315mm	940mm
B40901	400mm	940mm

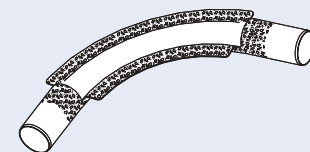
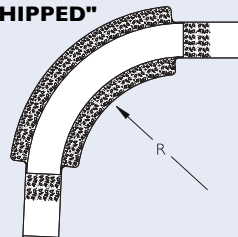

Long Radius Channel Bends in GB are sold without the lip.

45° LONG RADIUS PLAIN END CHANNEL BEND

CODE	SIZE	RADIUS
B2532	110mm	450mm
B3332	160mm	940mm

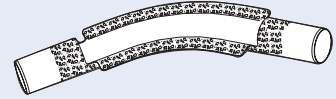
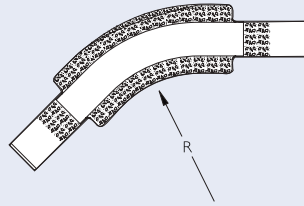

45° PLAIN END CHANNEL BEND "LIPPED & CHIPPED"

(DOE (NI) Approved Cert. No P/OL/WSC 5.3.91)

CODE	SIZE	RADIUS
B2045I	200mm	940mm
B2545I	250mm	940mm
B3145I	315mm	940mm
B4045I	400mm	940mm

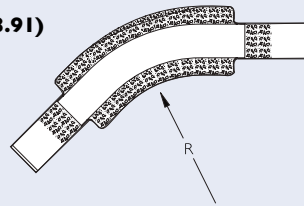

30° PLAIN END CHANNEL BEND "LIPPED & CHIPPED"

(DOE (NI) Approved Cert. No P/OL/WSC 5.3.91)

CODE	SIZE	RADIUS
B2030I	200mm	940mm
B2530I	250mm	940mm
B3130I	315mm	940mm
B4030I	400mm	940mm

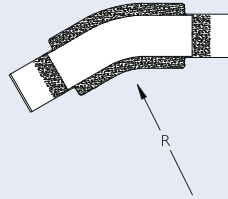

15° PLAIN END CHANNEL BEND "LIPPED & CHIPPED"

(DOE (NI) Approved Cert. No P/OL/WSC 5.3.91)

CODE	SIZE	RADIUS
B2015I	200mm	940mm
B2515I	250mm	940mm
B3115I	315mm	940mm
B4015I	400mm	940mm

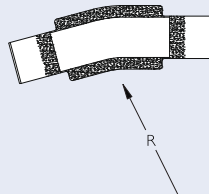

22 1/2° LONG RADIUS PLAIN END CHANNEL BEND

CODE	SIZE	RADIUS
B2533	110mm	450mm
B3333	160mm	940mm

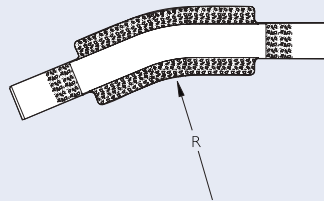

11 1/4° LONG RADIUS PLAIN END CHANNEL BEND

CODE	SIZE	RADIUS
B2534	110mm	450mm
B3334	160mm	940mm

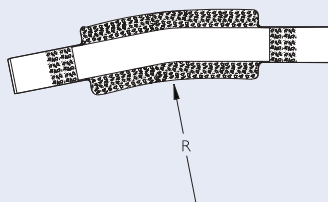

Long Radius Channel Bends in GB are sold without the lip.

3/4 SECTION BRANCH BEND 30° LEFT HAND

CODE	SIZE
B2221	110mm
B3371	160mm

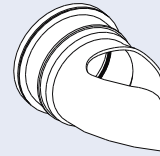
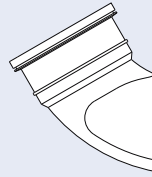

3/4 SECTION BRANCH BEND 30° RIGHT HAND

CODE	SIZE
B2621	110mm
B3372	160mm

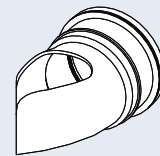
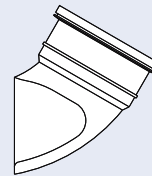

3/4 SECTION BRANCH BEND 90° LEFT HAND

CODE	SIZE
B2251	110mm
B3401	160mm

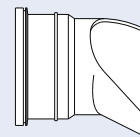
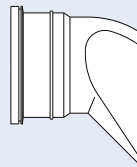

3/4 SECTION BRANCH BEND 90° RIGHT HAND

CODE	SIZE
B2651	110mm
B3402	160mm

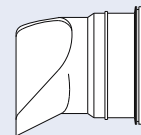
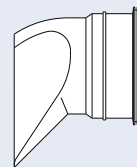

Other 3/4 section branches and bends are available to order.

ROAD GULLIES WITH INTEGRAL TRAP

CODE	SIZE	INVERT	DIAMETER
B9450	160mm	900mm	450mm
B7450	160mm	750mm	450mm

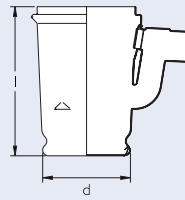

87 1/2° ACCESS BEND

CODE	SIZE
B1839	110mm

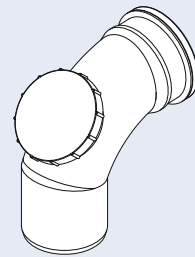
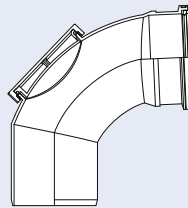

SINGLE SOCKET ACCESS PIPE

CODE	SIZE	Y
B5104	110mm	240mm
B7104	160mm	355mm

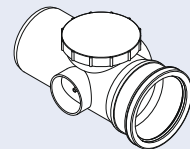
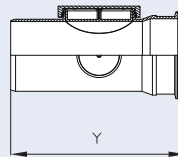

ALUMINIUM RODDING POINT SOCKETED AND SEALED

CODE	SIZE	X	Y	Z
B5592	110mm	114mm	47mm	188mm
B6691	160mm	138mm	64mm	254mm

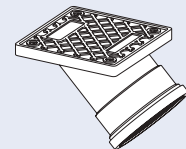
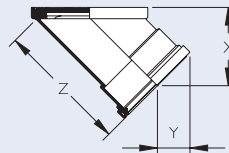

ALUMINIUM RODDING POINT - OVAL

CODE	SIZE	X	Y	Z
B5591	110mm	89mm	39mm	166mm

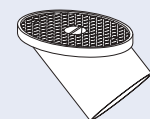
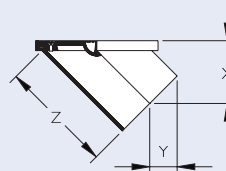

SCREW ACCESS COVER 

CODE	SIZE	X
B5091	110mm	80mm
B7071*	160mm	130mm

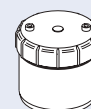
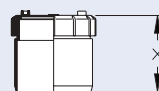

The following Access Pipe Screw on Covers are available on request: **B20122** 200mm, **B25122** 250mm, **B31122** 315mm, **B40122** 400mm

*Not kitemarked

TWINWALL PIPE

CODE	(SOLID)CODE (PERF)	SIZE	LENGTH
1TP6	1TPP6	150mm	6m
2TP6	2TPP6	225mm	6m
3TP6	3TPP6	300mm	6m
37TP6	37TPP6	375mm	6m
45TP6	45TPP6	450mm	6m
60TP6	60TPP6	600mm	6m

Half Perforated Pipe options are available to special order for 150mm, 225mm and 300mm diameters.

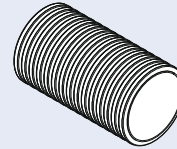

COUPLERS

CODE	SIZE
1TC	150mm
2TC	225mm
3TC	300mm
37TC	375mm
45TC	450mm
60TC	600mm

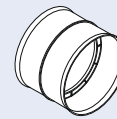

SEALING RING

CODE	SIZE
1TSR	150mm
2TSR	225mm
3TSR	300mm
37TSR	375mm
45TSR	450mm
60TSR	600mm

DOUBLE SOCKET BEND

CODE	A (suitable pipe size)	B	C	D	E
1TB15	150mm NB Twinwall Pipe	15°	303mm	272mm	90mm
1TB30	150mm NB Twinwall Pipe	30°	377mm	309mm	90mm
1TB45	150mm NB Twinwall Pipe	45°	403mm	334mm	90mm
1TB90	150mm NB Twinwall Pipe	90°	378mm	378mm	90mm
2TB15	225mm NB Twinwall Pipe	15°	400mm	380mm	125mm
2TB30	225mm NB Twinwall Pipe	30°	479mm	422mm	125mm
2TB45	225mm NB Twinwall Pipe	45°	537mm	462mm	125mm
2TB90	225mm NB Twinwall Pipe	90°	521mm	521mm	125mm
3TB15	300mm NB Twinwall Pipe	15°	461mm	472mm	140mm
3TB30	300mm NB Twinwall Pipe	30°	568mm	521mm	140mm
3TB45	300mm NB Twinwall Pipe	45°	648mm	570mm	140mm
3TB90	300mm NB Twinwall Pipe	90°	630mm	630mm	140mm

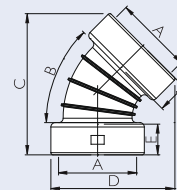

TRIPLE SOCKET BRANCHES - 45°

CODE	A (Suitable Pipe Size)	B (Suitable Pipe Size)	C	D	E	F
1TY45	150mm NB Twinwall Pipe	150mm NB Twinwall Pipe	486mm	90mm	90mm	448mm
2TY45	225mm NB Twinwall Pipe	225mm NB Twinwall Pipe	712mm	125mm	125mm	640mm
2TY145	225mm NB Twinwall Pipe	150mm NB Twinwall Pipe	662mm	125mm	90mm	552mm
3TY45	300mm NB Twinwall Pipe	300mm NB Twinwall Pipe	825mm	140mm	140mm	727mm
3TY245	300mm NB Twinwall Pipe	225mm NB Twinwall Pipe	865mm	140mm	125mm	790mm
3TY145	300mm NB Twinwall Pipe	150mm NB Twinwall Pipe	694mm	140mm	90mm	649mm

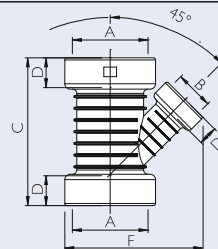

TRIPLE SOCKET BRANCHES - 90°

CODE	A	B	C	D	E	F
1TT90	150mm NB Twinwall Pipe	150mm NB Twinwall Pipe	461mm	90mm	90mm	338mm
2TT90	225mm NB Twinwall Pipe	225mm NB Twinwall Pipe	662mm	125mm	125mm	501mm
2TT190	225mm NB Twinwall Pipe	150mm NB Twinwall Pipe	587mm	125mm	90mm	448mm
3TT90	300mm NB Twinwall Pipe	300mm NB Twinwall Pipe	777mm	140mm	140mm	602mm
3TT290	300mm NB Twinwall Pipe	225mm NB Twinwall Pipe	674mm	140mm	125mm	572mm
3TT190	300mm NB Twinwall Pipe	150mm NB Twinwall Pipe	614mm	140mm	90mm	537mm

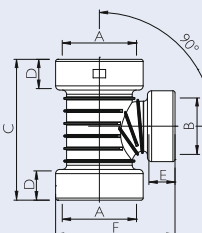

Note: Other fittings are available up to 600mm dia. to special order

6m BLOWN SOCKET DUCT PIPE

CODE	SIZE	Y	LENGTH	WT
BD2	53.9mm	55mm	6m	1.6mm
BD3	89mm	75mm	6m	1.8mm
BD4	110mm	100mm	6m	2.2mm
BD6	160mm	125mm	6m	3.3mm
BD8	200mm	125mm	6m	3.3mm

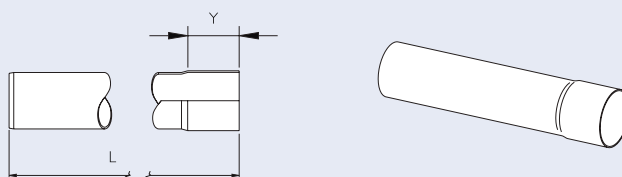

DUCT COUPLER

CODE	SIZE	Y
BD2C	53.9mm	140mm
BD3C	89mm	185mm
BD4C	110mm	250mm
BD6C	160mm	345mm
BD8C	200mm	475mm

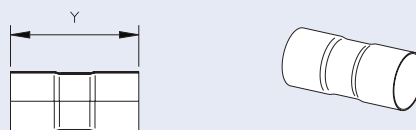

87 1/2° LONG RADIUS BLOWN SOCKET DUCT BEND

CODE	SIZE	R
BD2B	53.9mm	300mm
BD3B	89mm	300mm
BD4B	110mm	450mm
BD6B	160mm	940mm

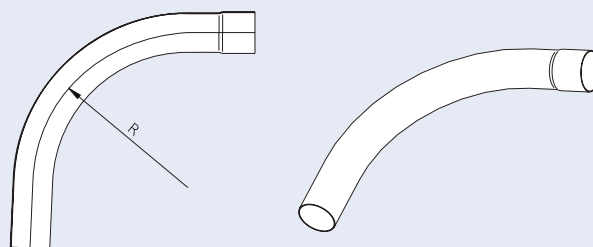

45° LONG RADIUS BLOWN SOCKET DUCT BEND

CODE	SIZE	R
BD2BA	53.9mm	350mm
BD3BA	89mm	350mm
BD4BA	110mm	450mm
BD6BA	160mm	940mm

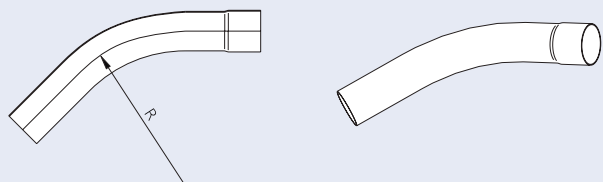

6m BLOWN SOCKET DUCT PIPE TO BS 4660 / BS 5481

CODE	SIZE	Y	LENGTH	WT
B401 ID	110mm	100mm	6m	3.2mm
B601 ID	160mm	125mm	6m	4.1mm
B801 ID	200mm	125mm	6m	4.9mm

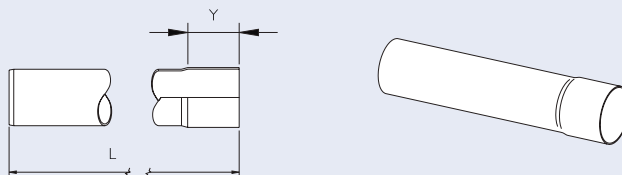

STORMCRATE (Standard Crate) (incl 4 joiners)

CODE	X	Y	Z
BRB33	1200mm	600mm	420mm

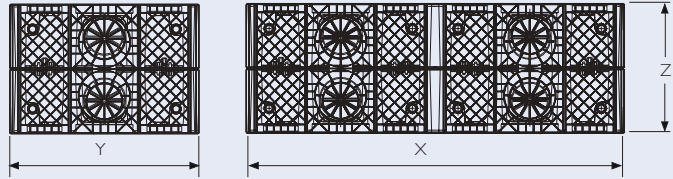

SPARE RUBBER RING FITTINGS

CODE	SIZE
B9161	110mm
B9121	160mm

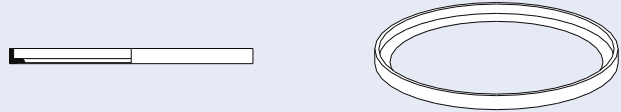

RING SEAL (PIPE)

CODE	SIZE
S/S110	110mm
S/S160	160mm
B20000	200mm
B25000	250mm
B31000	315mm
B40000	400mm

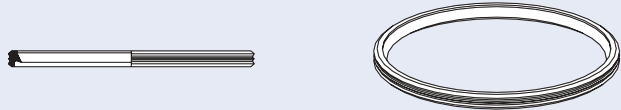

SOLVENT CLEANER

CODE	SIZE
B9031	250ml
B9032	500ml



SOLVENT CEMENT

CODE	SIZE
B9020	125ml
B9021	250ml
B9022	500ml
B9023	250ml - Heavy Duty

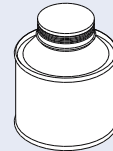

PIPE LUBRICANT

CODE	SIZE
B5399	78ml
B9333	0.5kg Tub (Gel)
B9444	5kg Tub (Gel)
B9555	400ml(Spray)

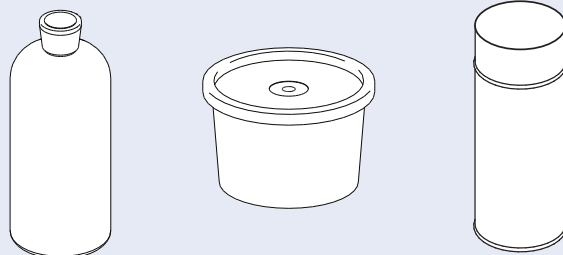

TECHNICAL INFORMATION

FUNCTION	38
AUTHORITY	38
STANDARDS	38
COMPOSITION	38
BIOLOGICAL AND CHEMICAL RESISTANCE	38
GENERAL RESISTANCES	38

GENERAL INFORMATION

STORAGE	39
HANDLING	39
TRANSPORT	39

INSTALLATION

	Page
INSTALLATION – GENERAL POINTS	40
FLOW PROPERTIES	40
CHOICE OF GRADIENTS	41
PIPE SIZING	41
FLOW PROPERTIES – CLEAN SEWERS	42
FLOW PROPERTIES – MATURE SEWERS	43
FLOW PROPERTIES – ROUGH BORE	44
SPECIAL PROTECTION – GROUND LOADS	45
TRENCH PREPARATION	45
MATERIALS FOR BEDDING	46
EASE OF COMPACTION	47
PIPE LAYING	47
SPECIAL PROTECTION – SETTLEMENT	48
SPECIAL PROTECTION – SURCHARGING	48
ACCESS TO DRAINS	49
PREFORMED INSPECTION CHAMBERS	50-51
SHALLOW ACCESS CHAMBERS	52
ACCESS AND INSPECTION CHAMBERS	53
OPEN CHANNEL MANHOLES	54
BACKDROP MANHOLE CONSTRUCTION	55
RODDING ACCESS	56
HEAD OF DRAIN RODDING POINT	56
UNIVERSAL RODDABLE BOTTLE GULLY	57
RODDING ACCESS	57
TYPICAL LAYOUT USING RODDING	
ACCESS COMPONENTS	57
TYPICAL INSTALLATION (ENGLAND & WALES)	58
TRADITIONAL GULLY ASSEMBLY	58
HORIZONTAL BACK INLET ASSEMBLY	59
BOTTLE GULLY ASSEMBLY	59
SOIL PIPE CONNECTION (SHORT RADIUS)	59
SOIL PIPE CONNECTION (LONG RADIUS)	60
RAINWATER PIPE CONNECTIONS	60
SADDLE BRANCH, BRANCH ENTRIES	60
PIPE JOINTS	61
CUTTING	61
PUSH-FIT JOINTING	61
PERFORATED PIPE	62
SOLVENT CEMENT JOINTING	63
CONNECTION TO UNDERGROUND DRAINAGE	64
MAINTENANCE	64
CHEMICAL RESISTANCES	65-67

TECHNICAL

FUNCTION

Brett Martin Underground Drainage offers a comprehensive range of drainage systems. It includes the Drain, Sewer, Perforated, Surface Water and Cable Duct systems. The entire range incorporates pipes and fittings in eight diameters from 53.9mm to 400mm.

Brett Martin Drain and Sewer Systems are complemented by the Brett Martin Surface Water and Soil and Waste systems providing a complete solution for all your drainage requirements.

AUTHORITY

Brett Martin Drainage systems satisfy the requirements of the following:-

- The Building Regulations 2010, Approved Document H
- Building (Scotland) Regulations 2004, Technical Handbook (Domestic & Non-Domestic) Section 3: Environment
- Building Regulations (Northern Ireland) 2012, Technical Booklet N
- Building Regulations 2010, Technical Guidance Document H (ROI)

STANDARDS

Brett Martin Drainage systems are manufactured under the following British and European Standards:-

- BS EN ISO 9001:2015 Quality Management Systems
- BS EN 1401-1:2009 Plastic piping systems for non-pressure underground drainage and sewerage (SN4). Unplasticized poly(vinyl chloride) (PVC-U). Part 1: Specifications for pipes, fittings and the system.
- BS EN 13598-1:2010 Plastics piping systems for non-pressure underground drainage and sewerage. Unplasticized poly(vinyl chloride) (PVC-U), polypropylene (PP) and polyethylene (PE). Part 1: Specifications for ancillary fittings including shallow inspection chambers.

COMPOSITION

Extruded pipe sections and injection moulded fittings are made from PVCu and polypropylene compounds complying with the material requirements of the relevant British Standards. They contain the necessary processing additives, stabilisers and pigments to give products excellent appearance, durability and performance.

BIOLOGICAL AND CHEMICAL RESISTANCE

Polluted industrial atmospheres will not effect Brett Martin drainage systems. PVC is vermin and rot proof and resistant to most commonly occurring chemicals: notable exceptions however are solvents, including those incorporated in most timber preservatives.

GENERAL RESISTANCES

Expected action

G - Good/Excellent resistance to attack

P - Poor resistance to attack

SUBSTANCE	EXPECTED ACTION
Mineral Acids (Diluted)	G
Mineral Acids (Concentrated)	G
Alkalis	G
Alcohol's	G
Ketones	P
Aromatic Hydrocarbons	P
Chlorinated Hydrocarbons	P
Greases and Oils	G

STORAGE

The following recommendations relate to the storage of PVCu pipes under the normal climatic conditions of the United Kingdom.

- a) Pipes should be stacked on a reasonably flat surface free from sharp projections, stones and other protuberances. Side supports should be provided at intervals of not more than 1.5m and these supports should preferably consist of battens not less than 75mm wide. However, if pipes are delivered in factory strapped bundles, no side supports are necessary.
- b) Pipes should be uniformly supported throughout their length, if this is not possible timber battens at least 75mm wide at spacings not greater than 1m centres should be placed beneath the pipes. Preferably pipes of different sizes and wall thicknesses should be stacked separately. Where this is not possible the pipes with larger diameters and thicker walls should be at the bottom. It is preferable that pipes should not be stacked one inside the other.
- c) If spigot and socket pipes are stacked, sockets should be placed at alternate ends of the stack with sockets protruding so that the pipes are evenly supported along their entire length. Pipe stacks should not exceed 7 layers with a maximum height of 2m.

HANDLING

Pipes made from PVCu are strong, though lightweight and are therefore very easily handled. However, it is necessary to take care to prevent damage; in particular, pipes should not be thrown, dropped or dragged along. If pipes are moved by rolling it is necessary to support them along their length and properly restrain them on inclines.

If pipes are loaded or unloaded by mechanical means (forklift, crane etc.) care should be taken to prevent damage. Pipes should be properly supported in two places when lifted. Preferably protected slings should be used, if metal chains and hooks are all that is available, padding should be placed between them and the pipes. If pipes are delivered stuffed, special care should be taken to avoid damage during unloading.

IMPORTANT

The impact strength of PVCu is reduced in cold weather during which time extra care must be taken to prevent site damage.

TRANSPORT

Vehicles with a flat bed should be used for the transport of pipes. The bed should be free from nails or other projections. Each pipe should be supported uniformly along its length. Vehicles should have adequate side supports at not more than 1.5m centres and pipes should be well secured during transit. All uprights should be flat and free from sharp edges.

When loading spigot/socket pipes, they should be stacked in alternate layers so that the sockets do not carry any load.

Pipes should be loaded onto vehicles in such a way that any overhang does not exceed 1m. Thick walled pipes must be loaded before thin walled pipes.

GENERAL

The ability of a rigid pipe to support the total load transmitted to it is established by reference to actual crushing tests to cause fracture. Flexible pipes such as those made from unplasticized PVC do not fracture under load but they are liable to deformation. The extent of this deformation depends largely upon the compaction of the immediate surrounding fill. For this reason, flexible pipes should always be surrounded with non-cohesive material. This surround should extend to the trench width in normal trench situations. The external loads (backfill and surcharge) imposed on a pipe of rigid material (such as vitrified clay, concrete, asbestos cement or cast iron) are supported mainly (sometimes wholly) by the resistance of the pipe to circumferential bending. On the other hand unplasticized PVC pipes, being relatively flexible, offer less resistance to circumferential deformation and rely partly on external support to resist deformation. Therefore, it is of primary importance for unplasticized PVC pipes that fill material, particularly the bedding and sidefill, should be properly compacted in order to prevent excessive deformation.

It is desirable that vertical deformation should be limited to 5% on completion of the backfilling, which can only be achieved by proper compaction of the backfill (Please refer to Codes of Practice BS 5955 and BS EN 752).

It is essential to avoid high stress concentrations and sharp objects such as large stones or flints which should not be allowed to come into contact with the surface of the pipe.

The flexible nature of unplasticized PVC pipes helps them to accommodate deformations resulting from ground movement or from other differential settlement under normal circumstances.

Except in special circumstances, e.g. at very shallow cover depths or where it is necessary to safeguard the foundations of existing structures, the use of concrete for bedding or surrounding the pipes is unnecessary. Figure 4 (in "Special Protection - Ground Loads" section) illustrates the use of concrete in special local circumstances.

Normally drainage pipework is laid in straight lines. However, in special circumstances and subject to approval it may sometimes be acceptable to "spring" the jointed pipes to a slight curve to avoid an obstacle, or to follow the curvature of a street. If this is done, and the joints are of the push-in type, care has to be taken not to spring the pipework to, too sharp a curve or the joints may be overstrained and fail later. The manufacturer should be consulted as to the minimum radius that can be accommodated in this way. Straining of the joints can be minimised by firmly backfilling a short length of pipe. The pipe should be anchored in this position by further backfilling before the next joint is made, and the process repeated as necessary. The trench may need to be widened on the curve to accommodate the pipe in its straight position. It is essential that the jointing is always carried out in the straight position.

FLOW PROPERTIES

The following is based upon information given in the code of practice BS 5955: Part 6: 1980.

For the purposes of calculating flow rates through PVCu pipes, reference should be made to the Colebrook-White equation. Figures have been derived using values for roughness (k_s) given in the "Hydraulic Research Station Charts", 4th edition (metric), 1978 and "Tables for the hydraulic design of pipes" (metric edition), 1977 for the sizes of PVCu pipes dealt with in this code. It is recommended that the information given in Figure 3(b) is used for velocities less than 1m/s.

These values of roughness are for guidance only and may need future modification in the light of continuing research work.

CHOICE OF GRADIENTS

Choice of gradients should be such as to maintain self-cleansing velocity under normal discharge conditions.

To achieve a satisfactory installation, diameter and gradient should be adequate for the maximum flow and competent supervision should be provided to ensure a high standard of pipe quality, laying, jointing and workmanship. This is particularly important when pipes are laid to flat gradients.

The following guidelines on gradients should be observed:

- a) For flows of less than 1 L/s, pipes not exceeding 100mm nominal bore at gradients not flatter than 1:40 have proved satisfactory.
- b) Where the peak flow is more than 1 L/s, a 100mm nominal bore pipe may be laid at a gradient not flatter than 1:80, provided that at least one WC is connected.
- c) 150mm nominal bore pipe may be laid at a gradient not flatter than 1:150, provided that at least five WC's are connected.
- d) Experience has shown that for gradients flatter than those given in items a) and c), a high standard of design and workmanship is necessary if blockages are to be minimised. Where this has been achieved, gradients of 1:130 for 100mm nominal bore pipes and 1:200 for 150mm nominal bore pipes have been used successfully.

Where the available fall is less than that necessary to achieve the recommended gradient, increasing the pipe diameter particularly at low flows is not a satisfactory solution. It will lead to a reduction in velocity and depth of flow and an increase in the tendency for deposits to accumulate in the pipes.

Where it is expected that a drain may be affected by settlement, the selected gradient should be such as to ensure that a satisfactory fall will be maintained.

Research has shown that high velocities of sewage flow arising from steep gradients do not cause increased erosion of pipes or deposition of solids. In such situations drains should be laid at gradients, which are the most economical in excavation and cost. High velocities can, however, cause excessive turbulence at bends and manholes and lead to fouling. Where this occurs it can be mitigated for example by using long radius or sealed access fittings.

PIPE SIZING

PVCu PIPE SIZES COMPARED WITH TRADITIONAL PIPE SIZES

The diameters of Brett Martin PVCu pipes increase in approximately 50mm increments compared with the 75mm generally for other materials, this enables pipes to be matched to design requirements more accurately and economically.

FIGURE 1 COMPARISON OF PIPE SIZES

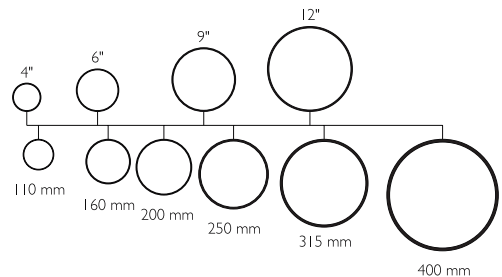

FLOW PROPERTIES

CLEAN SEWERS

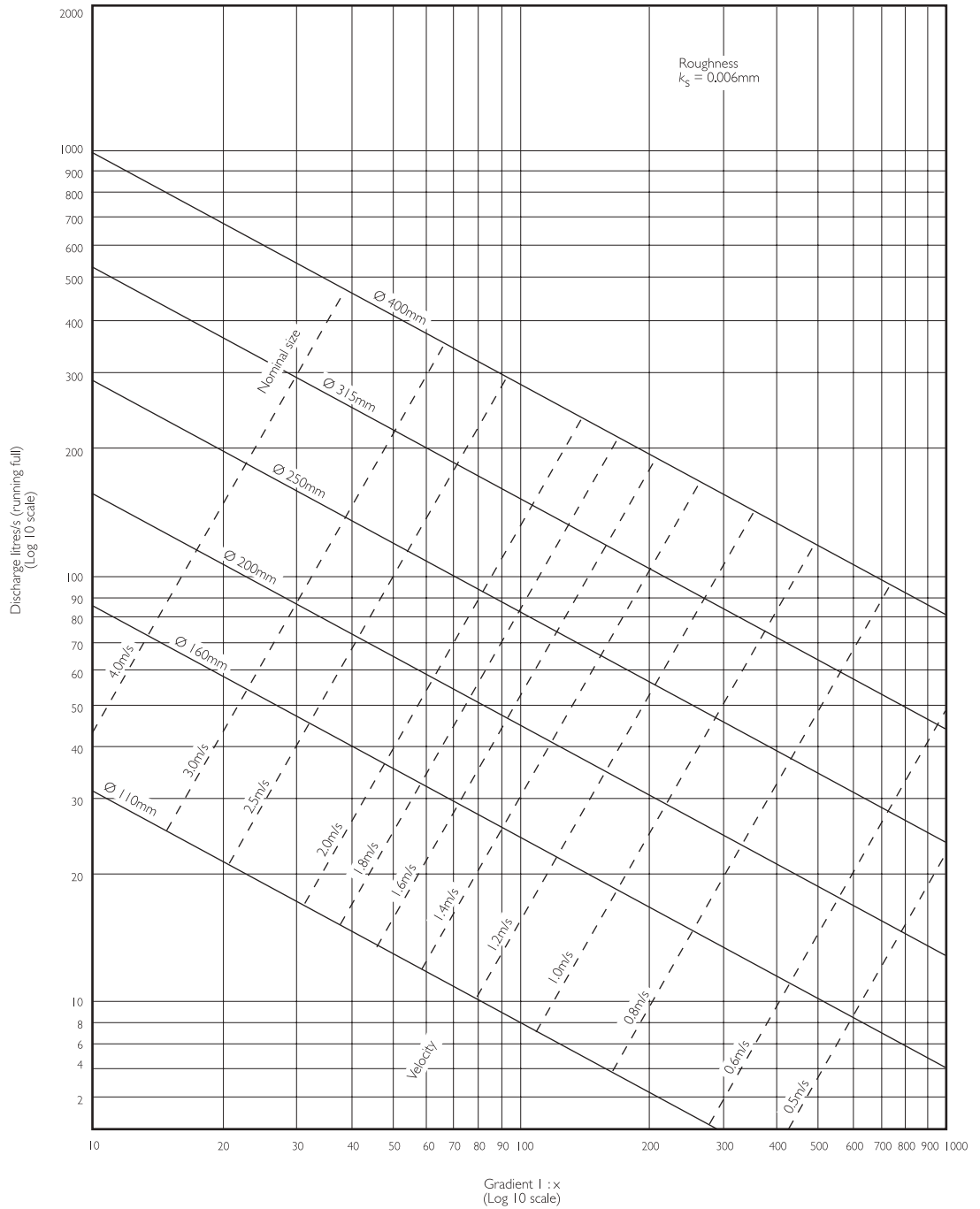

FIGURE 2

Discharge rates of clean sewers made from PVCu pipes in the nominal size range 110mm to 400mm for different gradients based on a roughness, k_s , of 0.006mm.

FLOW PROPERTIES

MATURE SEWERS

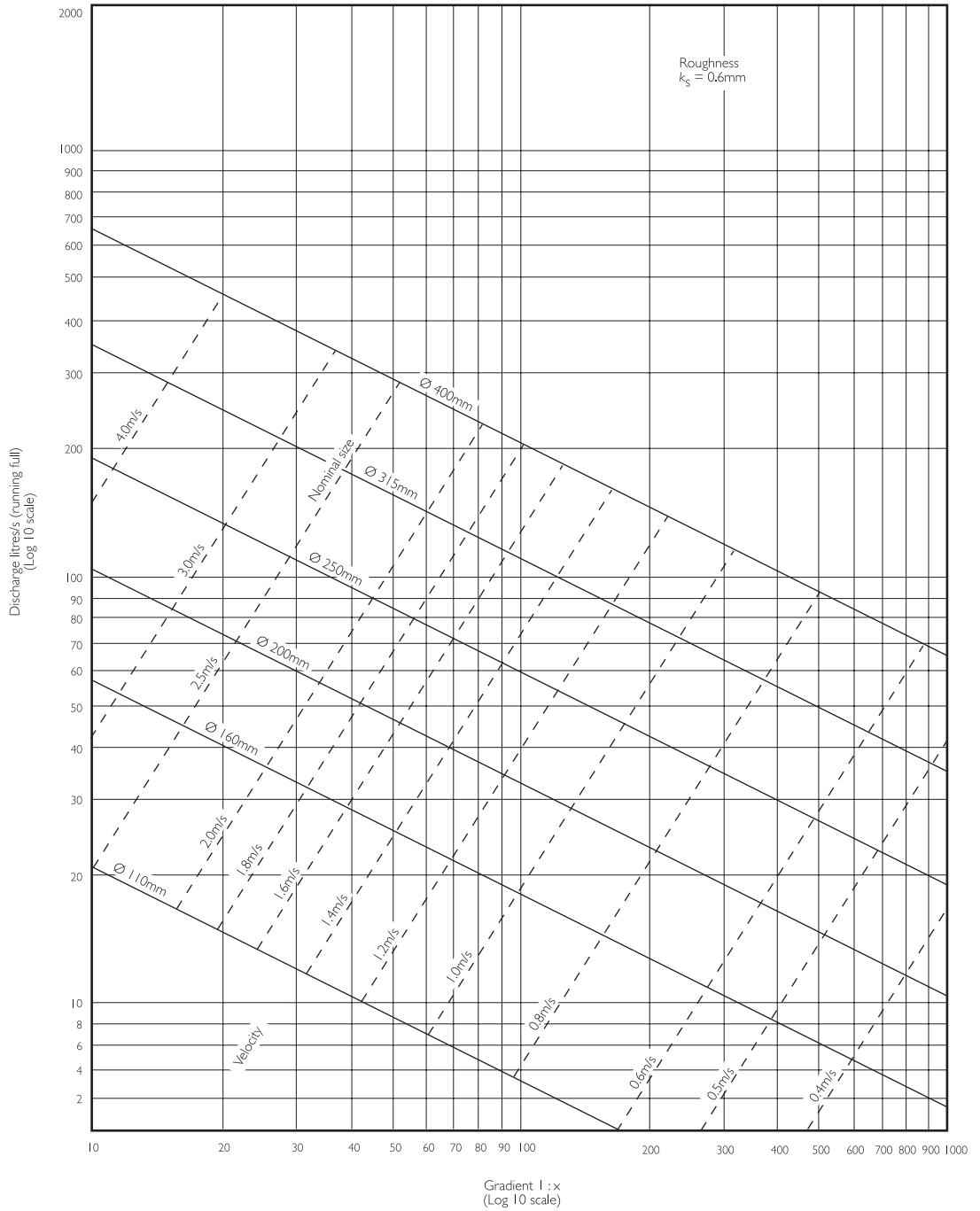

FIGURE 3

(a) Based on a roughness, k_s , of 0.6mm

Discharge rates of mature sewers made from PVCu pipes in the nominal size range from 110mm to 400mm for different gradients.

FLOW PROPERTIES

ROUGH BORE

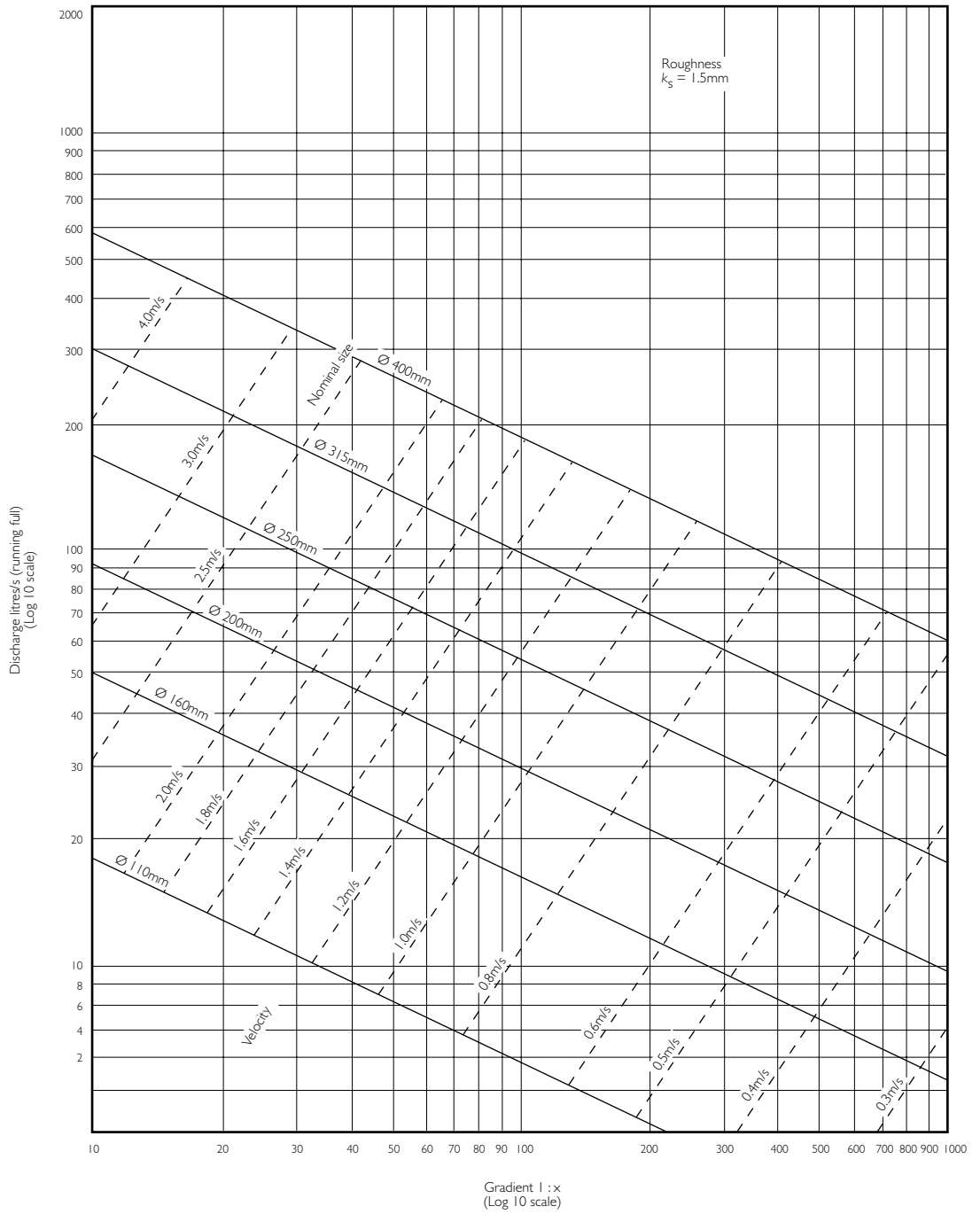

FIGURE 3 (CONCLUDED)
(b) Based on a roughness, k_s , of 1.5mm

**SPECIAL PROTECTION -
GROUND LOADS**

Where a rigid pipe of:-

- a) less than 150mm diameter has less than 300mm depth of cover; or
- b) 150mm or more diameter has less than 600mm depth of cover;

it should be surrounded with concrete either 100mm or the diameter of the pipe, whichever is greater, in thickness and have movement joints, at not more than 5m centres.

Where a flexible pipe has less than 300mm depth of cover under an area other than a vehicular area, it should have concrete paving slabs laid as bridging on granular or other flexible filling at least 75mm above the top of the pipe. Where a flexible pipe has less than 600mm depth of cover under a vehicular area it should have a reinforced concrete slab laid as bridging in a similar manner.

FIGURE 4
PROTECTION FOR FLEXIBLE PIPES

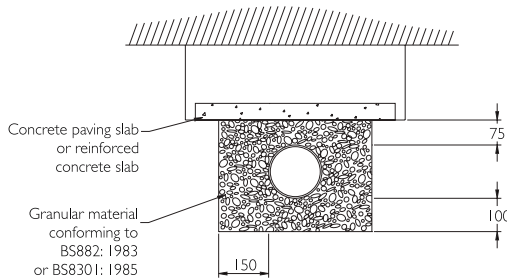

TRENCH PREPARATION

FIGURE 5
BEDDING FOR FLEXIBLE PIPES

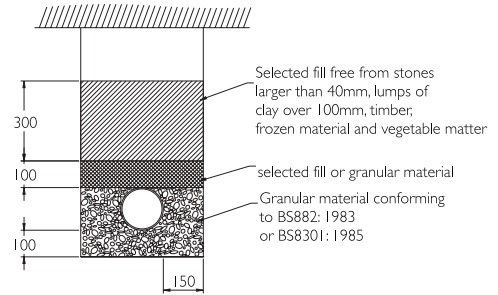

1. Provision shall be required to prevent ground water flow in open trenches.
2. The barrel of the pipe shall have continuous bearing on the floor of the trench or the granular fill.

The trench should not be opened too long in advance of pipe laying and should be backfilled as soon as possible. It is essential to ensure that the sides of the trenches are adequately supported in accordance with the requirements of BS6031. To minimise a possible hazard, a trench should be open for the minimum time practicable.

At the crown of the pipe and for 300mm, or one pipe diameter if greater, above it the width of the trench within any timbering should be as narrow as is practicable, but not less than the outside diameter of the pipe plus sufficient extra width (usually about 150mm) on each side of the pipe to provide access for making the joints and placing and compacting sidefill. Above this level, the trench may be of any convenient width.

If the "as-dug" material is suitable for use as bedding, the bottom of the trench may be trimmed to form the pipe bed. Otherwise, the trench should be excavated to an adequate depth below the invert level of the pipe to allow for the necessary thickness of bedding material. The thickness of bedding under the barrel of the pipes should be a minimum of 100mm, but in very wet or soft conditions or where the trench bottom is very irregular, it may be necessary to increase this thickness. Bedding should be properly compacted and finished so as to provide uniform support for the pipe. It is essential that bricks or other hard materials are not placed under the pipes for temporary or permanent support.

Material to be used for bedding and surrounding the pipes should be selected granular material, either available locally or, if necessary, brought to the site. Suitable materials are described in Table 1.

TABLE 1
SUITABLE MATERIAL FOR BEDDING AND SURROUNDING PIPES

Nominal pipe size (mm)	Material (complying with the requirements of BS882:Part 2)
110	10mm, nominal single-sized aggregate
160	10mm or 14mm, nominal single-sized aggregate or 14 to 5 graded aggregate
220 and over	10mm, 14mm or 20mm, nominal single-sized aggregate, or 14 to 5 or 20 to 5 graded aggregate

Alternatively, granular material in accordance with the following materials for bedding recommendations and having a particular size not exceeding that in Table 1 depending on pipe size, may be used.

MATERIALS FOR BEDDING

1 VISUAL EXAMINATION

Examine the material and reject any which contains pieces with sharp edges.

2 PARTICLE SIZE

The maximum particle size should generally not exceed 20mm. The presence of an occasional particle between 20mm and 40mm is acceptable provided the total quantity of such particles is only a very small fraction. If particles over 40mm are present, the material should be rejected.

The following test will ensure compliance with this recommendation.

A weighed representative sample of the material, about 50kg of the proposed material should be subdivided to give a 2kg test sample which is sieved, using test sieves of 19mm and 38mm nominal mesh size (see BS410).

Note 1: To obtain a representative sample, about 50kg of the proposed material should be heaped on a clean surface and divided with a spade down the middle. One of these halves should then be similarly divided, and so on until the required sample is left.

Note 2: In the sieving, clumps of material that break up under light finger pressure may be helped through the sieve, but considerable force should not be used to squeeze oversize clumps through the mesh.

The material is not recommended if:

- a) any particles are retained on the 38mm sieve, or
- b) more than 5% by mass of the sample is retained on the 19mm sieve.

EASE OF COMPACTION

i) Apparatus:

The following apparatus is required

- a) Open-ended cylinder 250mm long and 150 ± 6mm internal diameter (160mm diameter unplasticized PVC pipe is suitable)
- b) Metal rammer with striking face 40mm diameter and weighing 1.0 ± 0.1kg
- c) Rule

ii) Procedure

Obtain a representative sample (note 1) more than sufficient to fill the cylinder (about 11kg). It is important that the moisture content of the sample should not differ materially from that of the main body of material at the time of its use in the trench.

Place the cylinder on a firm flat surface and gently pour the sample material into it, loosely and without tamping. Strike off the top surface level with the top of the cylinder and remove all surplus spilled material. Lift the cylinder clear of its contents and place on a fresh area of flat surface. Place about one quarter of the contents back in the cylinder and tamp vigorously with the metal rammer until no further compaction can be obtained. Repeat with the second quarter; tamping as before, and so on for the third and fourth quarter; tamping the final surface as level as possible.

Measure down from the top of the cylinder to the surface of the compacted material. This distance in millimetres divided by the height of the cylinder (250mm) is referred to as the "compaction fraction".

Interpretation of results

TABLE 2

Compaction fraction (equivalent measurement from the top of the cylinder, mm)	Suitability for use
<0.20 (50)	Material Suitable
>0.20<0.3 (50 to 75)	Material may be suitable for applications other than installation carried out in compliance with the Civil Engineering Specification for the Water Industry but requires extra care in compaction. Not suitable if the ground is subjected to waterlogged conditions after laying.
>0.3 (75)	Material Unsuitable

PIPE LAYING

Unlike rigid pipes, pipes made from "flexible material" such as PVCu cannot be classified by their "crushing strength" but the fact that they are flexible does enable PVCu pipes to withstand forces from external loads and ground movement.

When a vertical load is imposed on a "flexible pipe" the resulting horizontal force is transmitted to the undisturbed trench wall by the sidefill. Any deflection of the pipe will cease when the horizontal reaction of the sidefill corresponds to the transmitted vertical load and a state of equilibrium is reached.

FIGURE 6
**MAXIMUM AND MINIMUM
RECOMMENDED DEPTHS**

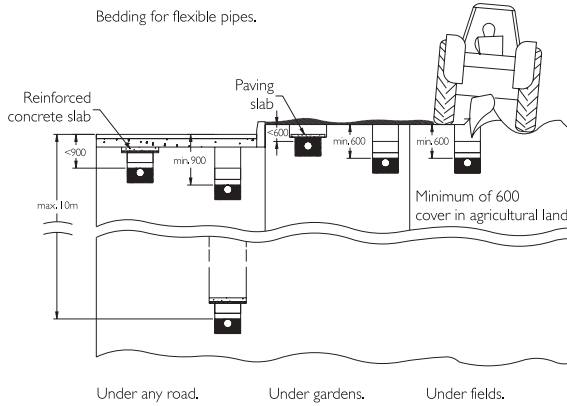

**SPECIAL PROTECTION -
SETTLEMENT**

A drain which runs under a building should be surrounded by at least 100mm of granular or other flexible filling.

It is recommended that a drain, which passes through a wall or foundation, should either:-

- a) pass through an opening giving at least 50mm clearance all round as shown in Fig 7(a); or
- b) be built in with, on each side, flexible joints within 150mm and rocker pipes of maximum length 600mm as shown in Fig 7(b).
- c) wall protection sleeves are available shown Fig 7(c).

FIGURE 7
PIPES PENETRATING WALLS

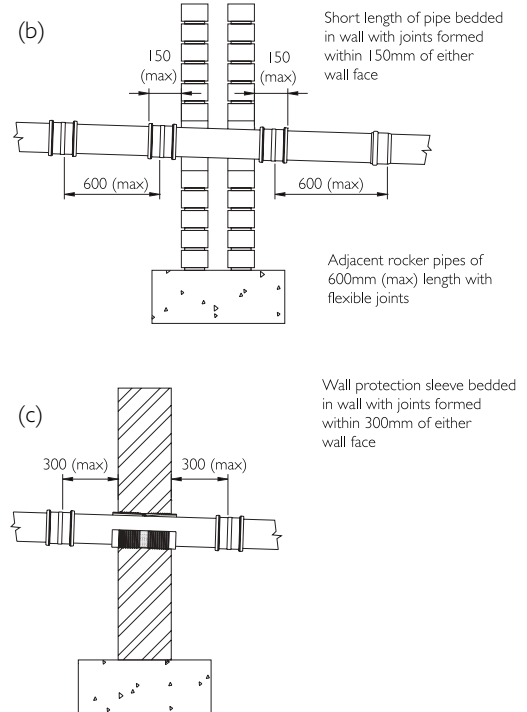
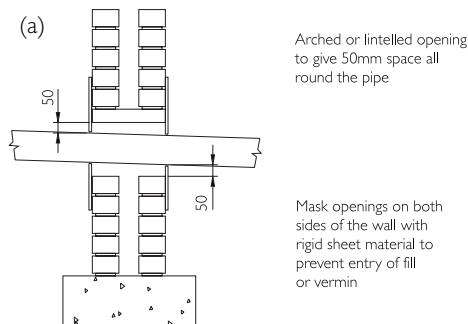

A drain which is at a level lower than the foundations of a building:-

- i) where the trench is within 1m of the foundations, it should be filled with concrete up to the level of the underside of the foundations; or
- ii) where the trench is more than 1m from the foundations, it should be filled with concrete to a level, below the level of the underside of the foundations, equal to the distance from the foundations less 150mm.

Flexible pipes must be wrapped in polythene before surrounding in concrete. The minimum thickness of the concrete surround should be 150mm or the diameter of the pipe, whichever is greater.

(Note: where a drain is to pass under a foundation it should be supported on piles, or where the ground is unstable, specialist advice should be sought on the required protective measures).

**SPECIAL PROTECTION -
SURCHARGING**

Where a drain is liable to surcharge, protective measures as described in standard BS EN 752 should be used.

ACCESS TO DRAINS

Access must be provided to drainage installations to allow for periodical maintenance, inspection and testing. Manholes, inspection chambers and shallow access chambers allow a system to be rodded in both directions whereas rodding eyes allow for only a downstream operation.

Basic principles state that every length of drain should be accessible for maintenance and rodding without the need to enter buildings. Access should be provided at the following points:

- i) At every change in direction

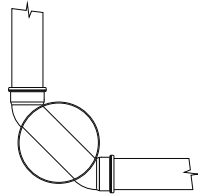

- ii) At the head of a drain

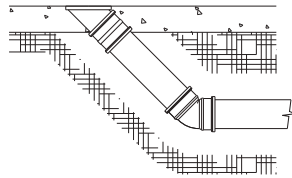

- iii) At any change in gradient

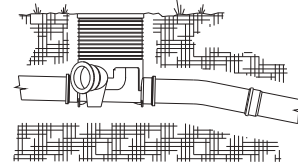

- iv) At any change in pipe diameter

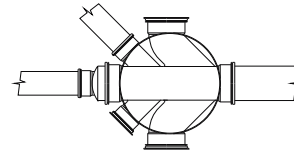

Table 3 indicates the maximum recommended spacing between various types of access points, based on standard rodding techniques and the necessity to clear blockages.

Where two drains join together via a branch junction and no provision of access is made on that junction then access should be provided no more than 12m from this point.

**TABLE 3
MAXIMUM SPACING OF ACCESS POINTS**

Distance to	To junction/ branch	To access fitting	To inspection chamber	To manhole
	m	m	m	mm
From start of external drain	-	12	22	45
From rodding point	12	12	22	45
From access fitting	12	12	22	45
From inspection chamber	12	22	45	45
From manhole	-	-	45	90
As per National Annex to BS EN 752:2017				

The depth of any inspection chamber or manhole is determined by its minimum internal dimensions, since there must be adequate access or entry for rodding and maintenance. Details listed on Table 4.

TABLE 4

MINIMUM DIMENSIONS FOR ACCESS FITTINGS AND CHAMBERS

Type	Depth to invert from cover level (m)	Internal sizes		Cover sizes	
		Length x width (mm x mm)	Circular (mm)	Length x width (mm x mm)	Circular (mm)
Rodding eye	-	As drain but min 100	-	-	same size as pipework ¹
Access fitting					
small 150 diameter	0.6 or less except where situated in a chamber	150 x 100	150	150 x 100 ¹	same size as access fitting
150 x 100		150 x 100	150	150 x 100 ¹	
large 225 x 100		225 x 100	225	225 x 100 ¹	
Inspection chamber					
Shallow	0.6 or less	225 x 100	190 ²	-	190 ²
	1.2 or less	450 x 450	450	Min 430 x 430	430
Deep	>1.2	450 x 450	450	Max 300 x 300 ³	access restricted to max 350 ³

Reference: The Building Regulations 2010, Approved Document H.

- ¹ The clear opening may be reduced by 20mm in order to provide proper support for the cover and frame.
- ² Drains up to 150mm.
- ³ A larger clear opening cover may be used in conjunction with a restricted access. The size is restricted for health & safety reasons to deter entry.

PREFORMED INSPECTION CHAMBERS

Prefomed inspection chambers can be used for invert depths of up to 3m, dependent on local specifications and building regulations. If the invert depth is greater than 1.2m this constitutes a no personnel entry Inspection Chamber and must have a restricted opening for health & safety reasons of less than 350mm to prevent personnel entry. The Reducer ring, code 6350, is available in such circumstances and should be fitted into the cover frame. The chamber should be placed on suitable compacted material so that it is evenly supported.

When the base is in position the bungs can be removed and pipes inserted as appropriate. The risers are then placed on the base to reach the desired invert. The top riser can be trimmed to suit finished ground level. It is recommended that the cover and frame are fitted at this point to stop any foreign matter from entering the chamber. Backfilling may then take place around the chamber base and the connecting pipes, using suitable granular material. Backfilling continues to within 160mm of ground level. A concrete plinth is then cast, in which the cast iron cover and frame sit.

FIGURE 8A.

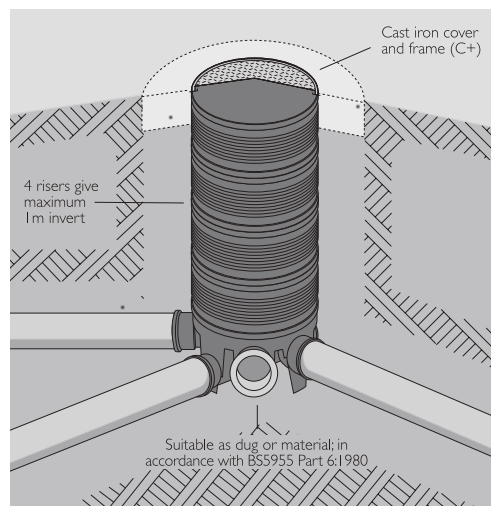

The straight through channel should be used for the main flow at all times as illustrated above. This reduces the likelihood of cross flow and helps show direction of flow for rodding purposes.

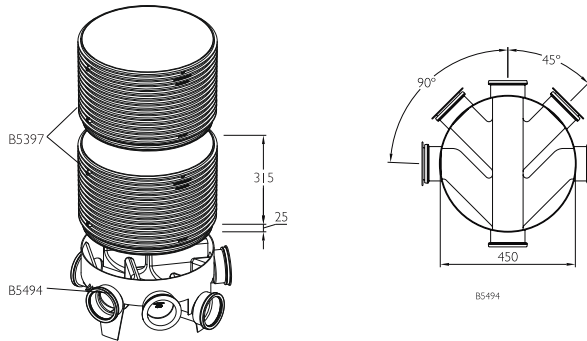

Product codes - Chamber Base B5494
Sectional Riser B5397

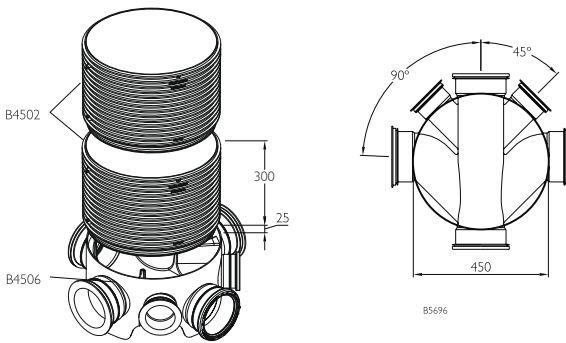

Radius on 90°/160mm inlets improves flow through the chamber.

Product codes - Chamber Base B4506
Sectional Riser B4502

Figure 8b illustrates some of the alternative configurations available when using pre-formed inspection chambers.

FIGURE 8B.

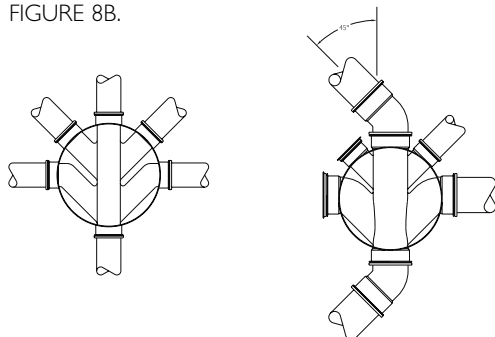

N.B. When turning through 90°, 2N° x 45° bends should be used as above, to incorporate the main channel throughout the change of direction.

TABLE 5

INSPECTION CHAMBER 450mm X 110mm & 450 X 160mm - KEY DIMENSIONS

INSPECTION CHAMBER – KEY DIMENSIONS (mm)				
Socket Diameter	Standard		to EN13598-1	
	110mm	160mm	110mm	160mm
Chamber Base Diameter	450	450	450	450
Chamber Base Product Code	B5494	B5696	B4500	B4506
Invert Depth of Base	225	255	225	255
Invert Depth of Riser	315	315	300	300
Invert Depth of Base and 1 Riser	540	570	525	555
Invert Depth of Base and 2 Risers	855	885	825	855
Invert Depth of Base and 3 Risers	1170	1200	1125	1155
Round Cover and Frame	33	33	33	33
Square Cover and Frame	48	48	48	48

TABLE 6

**NO ENTRY PERSONNEL
INSPECTION CHAMBER 450mm X 110mm & 450mm x 160mm - KEY DIMENSIONS**

INSPECTION CHAMBER – KEY DIMENSIONS (mm)		
Socket Diameter	to EN13598-1	
	110mm	160mm
Chamber Base Diameter	450	450
Chamber Base Product Code	B4500*	B4506*
Invert Depth of Base and 4 Risers	1425	1455
Invert Depth of Base and 5 Risers	1725	1755
Invert Depth of Base and 6 Risers	2025	2055
Invert Depth of Base and 7 Risers	2325	2355
Invert Depth of Base and 8 Risers	2625	2655
Invert Depth of Base and 9 Risers	2925	2955
Round Cover and Frame	33	33
Square Cover and Frame	48	48

NB: Restricted opening of 350mm diameter at ground level must be employed for chambers deeper than 1.2m

* B4500/B4506 used in adoptable applications for invert depths up to 1.2m and for non-adoptable applications at invert depths up to 3.0m

TABLE 7

SHALLOW ACCESS CHAMBER 280mm & 315mm - KEY DIMENSIONS

SHALLOW ACCESS CHAMBER – KEY DIMENSIONS (mm)			
Socket Diameter	110mm	Standard 110mm	to EN13598-1 110mm
	Chamber Base Diameter	280	315
Chamber Base Product Code	B2800	B1350	B3156*
Invert Depth of Base	205	190	190
Invert Depth of Riser	185	185	185
Invert Depth of Base and 1 Riser	390	375	375
Invert Depth of Base and 2 Risers	575	560	560
Cover and Frame	20.5	27.5	27.5

* B3156 used in adoptable applications for invert depths up to 0.9m and for non-adoptable applications at invert depths up to 0.6m

SHALLOW ACCESS CHAMBERS

The Brett Martin 280mm and 315mm dia Shallow Access Chambers are designed for use with 110mm pipework and are suitable for inverts up to 600mm.

The 280mm Chamber range offers two different bases, code B2800 incorporating one 45° inlet on each side and code B2803, which features a 90° change of direction of the main channel.

The more versatile 315mm dia base offers one 45° and one 90° inlet connection on each side and can, where suitable, reduce costs significantly by replacing the larger 450mm Inspection Chamber. Applicable to maximum inverts of 600mm only.

Chamber Risers for both assemblies incorporate ring seals that allow easy push fit joints between the base and each other. It is strongly recommended that lubricant is always used in making a ring seal joint. (See page 34 for options.) Each Riser adds 185mm to the Chamber assembly, with a maximum of two risers to be used. The 315mm dia Chamber Cover and Frames have long, ring sealed spigots that allow in certain circumstances for only one riser to be used.

The Cover and Frame code B2802, features a double seal and can be used internally, if required. When used externally, location must be in a pedestrian area only. However, the 315mm Chamber range includes two Cover and Frames, code B3153 for Pedestrian areas and a cover and frame, code B3154, which can be located in domestic driveways. Both 315mm dia Cover and frames feature double seals. It is recommended that all frames are located in a concrete plinth for stability and to spread the loading when used in a driveway location.

Another feature of the 315mm Cover and Frame is that the longer spigot allows for an offset connection to the Chamber Riser, to enable the cover to follow a sloping surface up to 15°.

All three Covers and Frames are square and are easily incorporated into paving or tarmac.

FIGURE 9

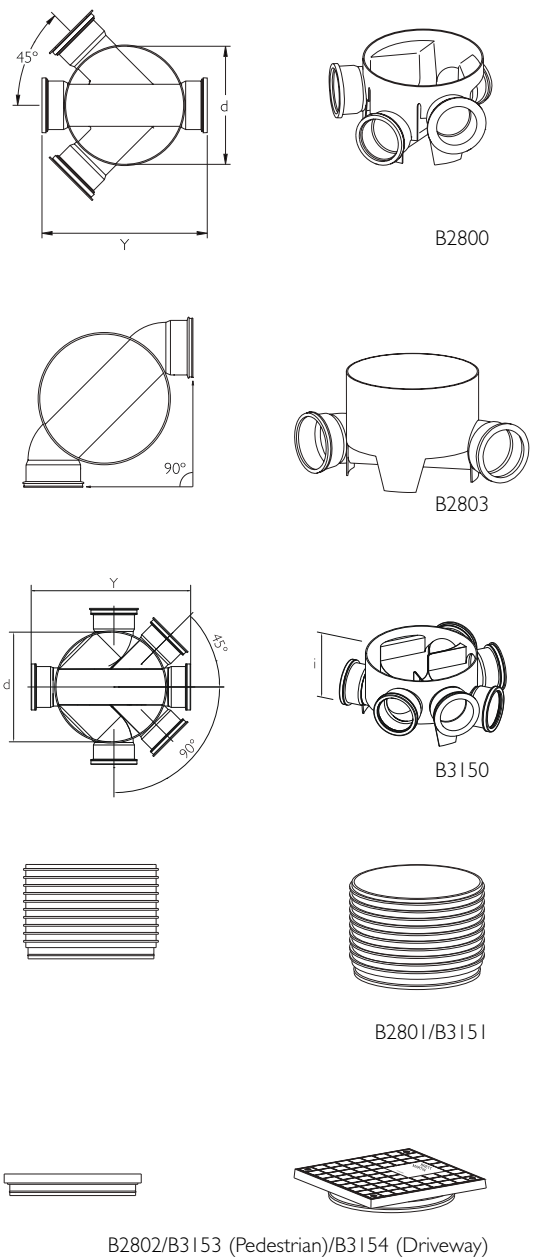

ACCESS AND INSPECTION CHAMBERS

Ensure that the base is embedded on a suitable substrate. This should either be suitable "as dug" material or materials in accordance with BS EN 1610:2015.



Check that the spigot on the riser is free from imperfections such as dents, burrs or cracks.

Clean both the spigot on the riser and the seal to ensure that they are free from any dirt which may impede their function.

When fitting the seal to the riser be careful not to stretch the seal any more than is required to fit it into the recess.



Add some lubricant around the seal and run your thumb around the seal to both ensure that the seal is housed in its groove/recess and to wipe away any excess lubricant.

Place the riser on top of the base/riser to which it will be fitted. The riser should be positioned so that seal sits on top of the chamber/riser below.

Position both hands diametrically opposed to one another and apply even pressure to push the riser downwards into the base/riser below until it is completely fitted. Ensure that the riser is inserted square to its axis and not fitted at an angle as this may push the seal out of its recess.

Check that the riser/base has no raised areas any deflection in front of the seal as this may indicate that the seal is dislodged.

Once the riser is in place, cable ties (or similar) can be used on the integral lugs on the side of both riser and bases. These are positioned between both base and riser or riser and riser in order to ensure that the riser cannot "pop out" of the base/riser below it during backfilling.



Care should be taken when backfilling so the chamber assembly is not disrupted by excessively or unequally backfilling. ^a

It is recommended that inspection chamber assemblies are water tested and visually inspected prior to backfill to ensure leak tightness. ^{a b}

Further water testing is also recommended once installation is complete. ^{a b}

^a To be carried out in accordance with BS EN 1610:2015.

^b Water testing requirement on installations is subject to local/national building regulations

OPEN CHANNEL MANHOLES

Brett Martin chamber bases can be used in the bottom of a constructed manhole arrangement. The chamber base is positioned carefully in concrete to give full support throughout its diameter. Benching is sloping upwards from the base to the manhole walls at a gradient of 1:12. All construction must be in accordance with BS EN 752, Figure 10.

FIGURE 10

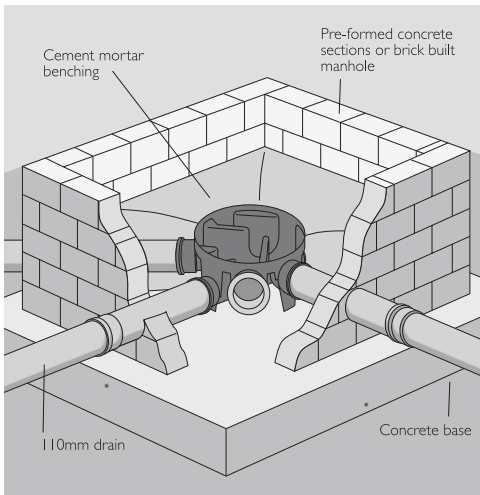

A large range of 1/2 and 3/4 channel fittings offer the contractor a wide choice of constructional methods.

Fittings are available in 110mm, 160mm and 200mm diameters. Channel fittings for larger bore pipe can be fabricated on request.

Two systems are available:

- (i) Level invert system Figure 11
- (ii) Stepped invert system Figure 12

A level invert system is advantageous when invert levels need to be accurate. The range consists of junctions, bends, tapers which have to be solvent welded into position. No solvent welding is required on a stepped invert system.

FIGURE 11

LEVEL INVERT SYSTEM

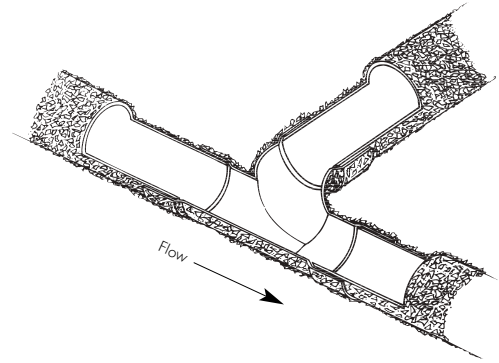
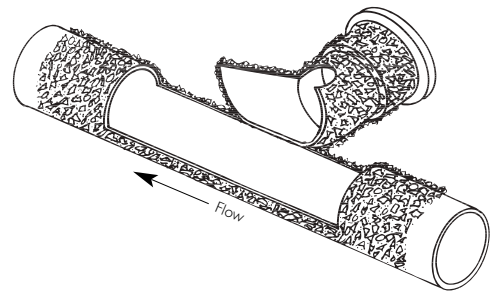

FIGURE 12

STEPPED INVERT SYSTEM



Solvent welding must be carried out in the following way to ensure a sound and lasting joint:

- (i) All spigot ends must be square and chamfered
- (ii) Both surfaces should be free from dirt and water
- (iii) With a clean brush apply Brett Martin Solvent Cleaner to both surfaces and allow to dry
- (iv) Again with a clean brush apply an even coat of Brett Martin Solvent Cement
- (v) Immediately insert the coated spigot into the socket and hold in place for about a minute

N.B. A narrow cut-off pipe may be sprung into the joint to hold the assembly in position. See Figure 13, but it must be removed when the joint is set.

FIGURE 13
SOLVENT WELDING

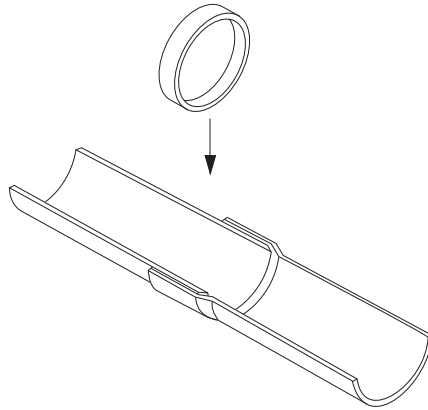

The full range of Brett Martin Channel Fittings are supplied with a keyed surface, to ensure excellent adhesion to the concrete benching.

FIGURE 14
ILLUSTRATES ALTERNATIVE ASSEMBLIES

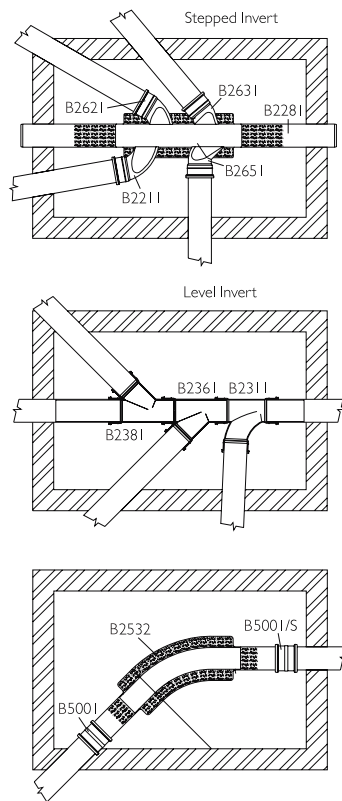

Many additional combinations are possible using the above and other Open Channel Fittings.

BACKDROP MANHOLE CONSTRUCTION

A backdrop installation is required when two or more pipes, at different invert levels, are to meet at one manhole. Minimum trench excavation is therefore needed to join the pipework together.

The vertical section of a backdrop can be constructed internally or externally.

FIGURE 15
INTERNAL BACKDROP

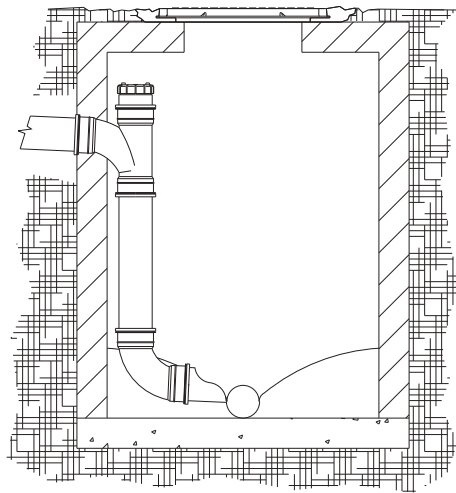

INTERNAL CONSTRUCTION

To construct an internal backdrop as illustrated in Figure 15 use:

- I No B5091 - Screw Access Cover
- I No B4081 - 87¹/₂° Triple Socket Branch
- I No B5041 - Single Socket Bend 87¹/₂° section of pipe for vertical drop

The vertical section should be securely fixed to the manhole wall using Pipe/Socket Fixing Brackets (BS407) from the Brett Martin Soil Range, and held with stainless steel screws.

FIGURE 16
EXTERNAL BACKDROP

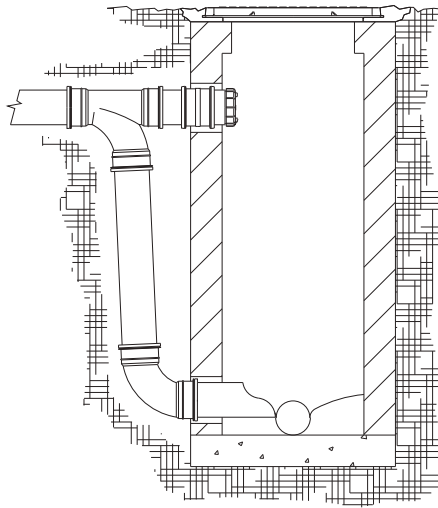

EXTERNAL INSTALLATION

The vertical section of the installation is this time outside the chamber wall. The fittings required to construct an external backdrop are as shown in Figure 16:

- 1 No B5091 - Screw Access Cover
 - 1 No B4081 - 87½° Triple Socket Branch
 - 1 No B5001 - Pipe Coupler
 - 1 No B4031 - Double Socket Bend 87½°
- plus a suitable section of vertical pipe

Note: 160mm installations may be constructed using similar 160mm fittings.

RODDING ACCESS

When installed correctly, the use of rodding points can eliminate the need for expensive Inspection Chambers and Manholes, significantly reducing the cost of installation.

HEAD OF DRAIN RODDING POINT

A Rodding Point as shown in Figures 17 and 18 can be used at the head of a drain in place of an inspection chamber or manhole. The rodding eye itself is made from cast alloy and has a 110mm spigot allowing easy connection to the system. Being set at 45° it allows easy rodding of the system.

FIGURE 17
HEAD OF DRAIN RODDING POINT

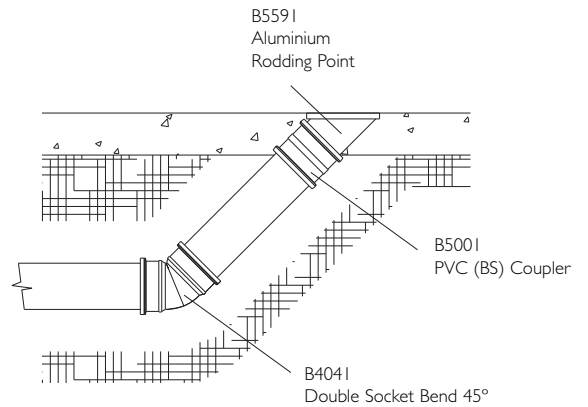

NB Sealed square and socketed version of the aluminium rodding point is also available code B5592.

FIGURE 18

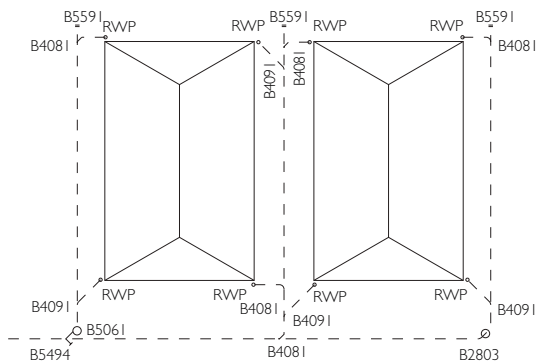

Shows how Rodding Points can minimise the number of inspection chambers and manholes on a typical surface water application.

**UNIVERSAL RODDABLE
BOTTLE GULLY**

The Brett Martin Universal Roddable Bottle Gully (as shown in Figure 19), may be used with a wide range of grids and sealing plates. It may be rotated leaving the grid square to the wall thus giving a more direct line of drainage resulting in economy of fittings.

A full 100mm diameter access, gained by the removal of the dip tube, enables a wide range of cleaning equipment to be used.

The unit can be used instead of a traditional gully assembly and in certain applications, can remove the need for an inspection chamber, Figure 19.

FIGURE 19
**RODDABLE BOTTLE GULLY
INSTALLATION DETAILS**

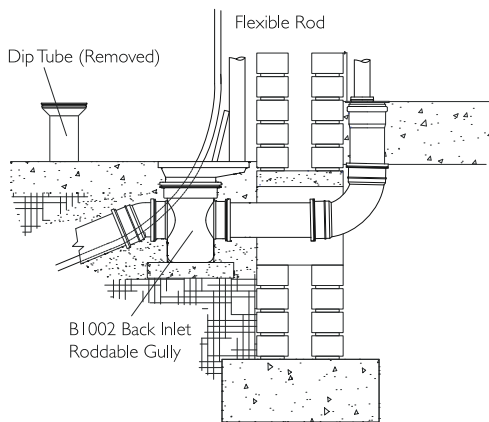

NB: All appliances connected to the black inlet of the bottle gully must be trapped separately

FIGURE 20
**HOW A RODDABLE BOTTLE GULLY CAN
ELIMINATE THE USE OF INSPECTION
CHAMBER OR MANHOLES**

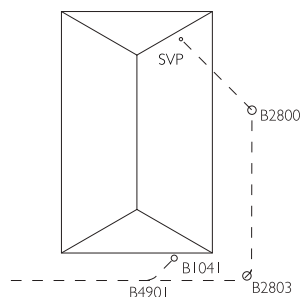

RODDING ACCESS

In areas where combined foul and surface water systems are permitted, the rainwater connections must be trapped. See Figure 21.

Concrete Floor Construction

FIGURE 21
**TYPICAL LAYOUT USING RODDING
ACCESS COMPONENTS**

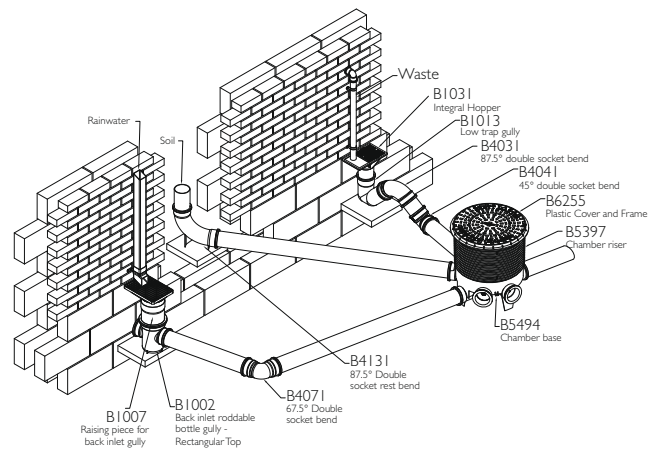

USEFUL INSTALLATION TIPS

- Always chamfer cut pipe and lubricate all plain ended spigots for perfect joints.
- Storm water connections are invariably less critical than those in the foul system. Therefore lay the foul drain system closest to the building and lay the storm system around this wherever possible.
- Where external soil stacks are connected to the side inlet of a preformed chamber, ensure that the distance between the two is a minimum of 750mm to help prevent cross flow of solids onto the opposite benching.
- Where combined drainage systems are installed ensure each rainwater pipe is connected to a gully.
- Always use the main channel of a chamber at a change of direction of the main run.

FIGURE 22

TYPICAL INSTALLATION (ENGLAND & WALES) - SURFACE WATER SYSTEM ONLY

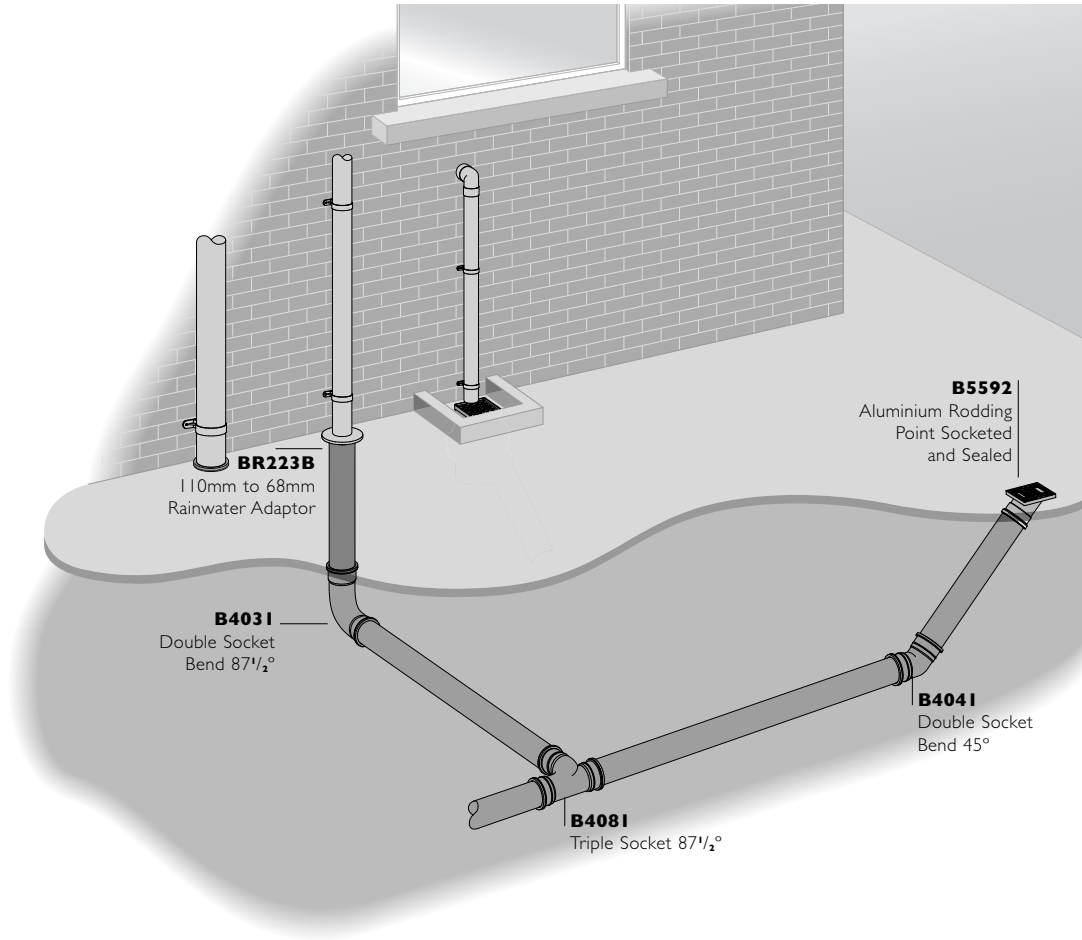

TRADITIONAL GULLY ASSEMBLY

The Low Trap Gully can be supplied in basic assembled form with a wide range of bends offering a choice of outlet.

The hopper should be attached to the trap out of the ground, and the whole assembly should be placed on a ready-made concrete slab, connected to the main drain, and backfilled with a selected granular material.

If the assembly is not protected by pavings or concrete at ground level e.g. in a garden, then a concrete slab should be bedded above the outlet bend to prevent damage from garden implements, Figure 23.

FIGURE 23

TRADITIONAL GULLY ASSEMBLY

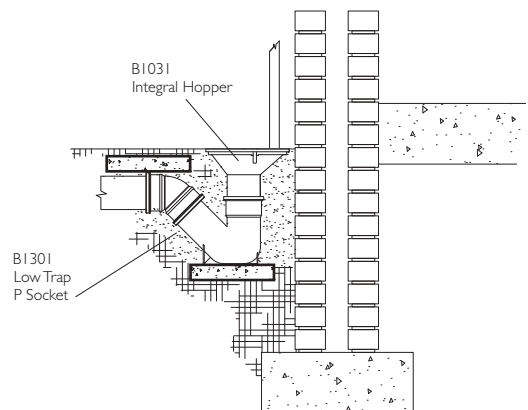

HORIZONTAL BACK INLET ASSEMBLY

Figure 24 shows the use of the Horizontal Back Inlet Hopper when collecting waste water from inside a building.

Gully risers can be used with the whole range of square hoppers and bottle gully when extra depth is necessary. The rest of the gully assembly is as the aforementioned installation.

FIGURE 24
HORIZONTAL BACK INLET ASSEMBLY

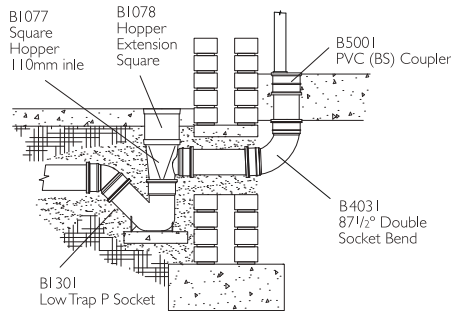

BOTTLE GULLY ASSEMBLY

The unique round to square adaptor enables the gully outlet to be rotated leaving the grid square to the wall thus giving a more direct line of drainage.

The base design allows the gully to stand freely on a firm base of bricks or concrete without additional support.

It has two bosses which will accept a 110mm pipe when the need for the true back inlet arises.

Installation is completed by bedding and surrounding the gully with selected granular material, Figure 25.

FIGURE 25
BOTTLE GULLY ASSEMBLY

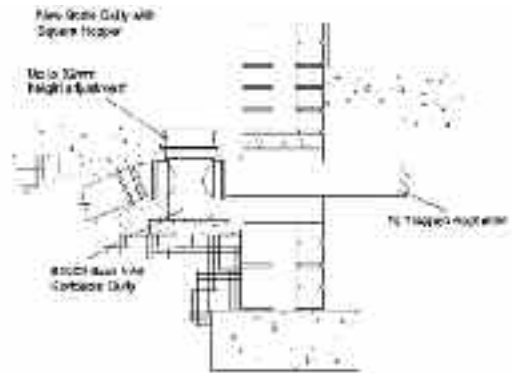

NB: All appliances connected to the back inlet of the bottle gully must be trapped separately.

SOIL PIPE CONNECTION (SHORT RADIUS)

Figures 26(a) and (b) show how to connect an internal soil stack to an underground drainage system using a two way knuckle bend.

FIGURE 26(a)
USUAL SOIL PIPE CONNECTION

Suitable where WC's are connected to the soil stack, the rest bend B4131 should be used.

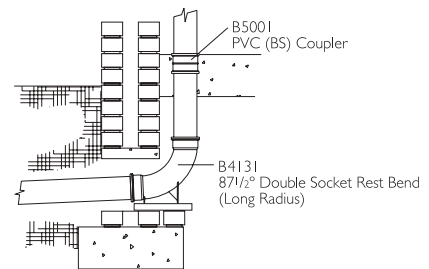
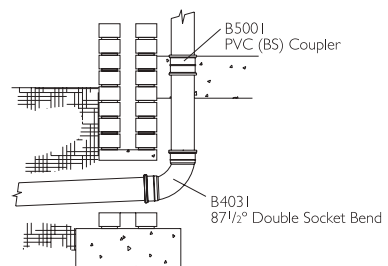

FIGURE 26(b)
SOIL PIPE CONNECTION (SHORT RADIUS)

Suitable where WC's are not connected to the soil stack. The pipe is then taken to ground level and connected to the stack with a coupler.



**SOIL PIPE CONNECTION
(LONG RADIUS)**

Figure 27 again shows the connection of underground drain to soil by the use of a long radius bend connected together with two couplers.

It is advisable to use a long radius bend when heavy or fast flows are expected e.g. flats (multi-storey dwellings).

FIGURE 27

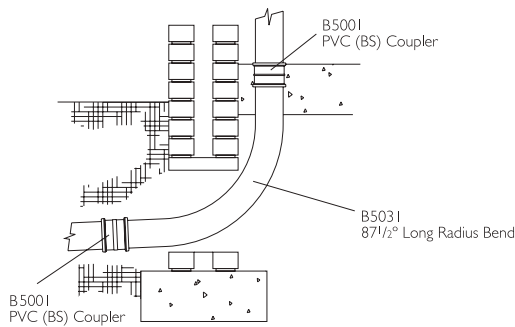

**RAINWATER PIPE
CONNECTIONS**

If rainwater pipes are to be situated externally then connections can be made by fitting a rainwater pipe adaptor to a pipe and via a knuckle bend as shown in Figure 28. Should the system be combined the rainwater pipe would have to be dropped into a trap assembly similar to that shown in Figure 23.

FIGURE 28

RAINWATER PIPE CONNECTIONS

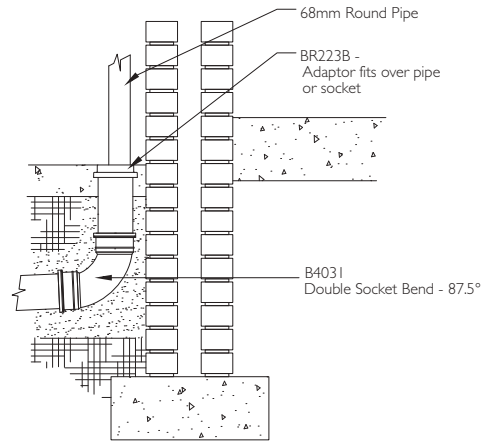

SADDLE BRANCH

BRANCH ENTRIES

To make new connections to existing 110mm and 160mm PVCu drains insert a suitable Junction and Slip Couplers.

To insert a new branch entry into larger diameter drains use a Saddle Junction, Solvent Weld is available in the Brett Martin range.

Solvent Weld Saddle Junctions are supplied in 110mm and 160mm sizes for 45° and 87 1/2° Branch entries and 200mm for connection at 45°.

FIGURE 29

**200mm X 110mm CONNECTIONS AT 45°
USING SOLVENT WELD JUNCTION ON
200mm DRAIN**

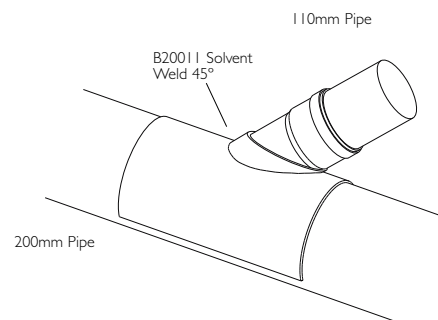

PIPE JOINTS

The Brett Martin Drainage system includes Adaptors to connect PVCu to clay or cast iron sockets or spigots. These connections are illustrated in Figures 30-33.

FIGURE 30
PVCu STANDARD CLAY ADAPTOR (B3500)

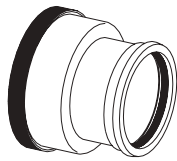

FIGURE 31
PVCu SUPER CLAY ADAPTOR (B3510)

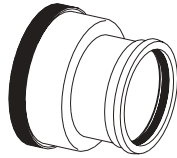
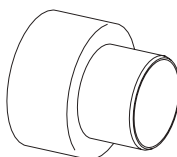

FIGURE 32
SALT GLAZE SOCKET ADAPTOR (B5131/B7161)



FIGURE 33
SALT GLAZE SPIGOT ADAPTOR (B5141/B7151)



CUTTING

Pipes can be cut with a hand saw having 6-8 teeth per cm, held at a shallow angle and sawing with slow steady strokes. A file should be used to remove any swarf and a chamfer should be made around the full circumference of the pipe.

PUSH-FIT JOINTING

To ensure watertight jointing the following procedure should be followed:

- Pipe ends should be cut square. Chamfer the end to approximately half the wall thickness and at an angle of about 15° using a file or rasp. Remove all swarf with a scraper or knife blade. Chamfers are moulded on spigot ends of all fittings.

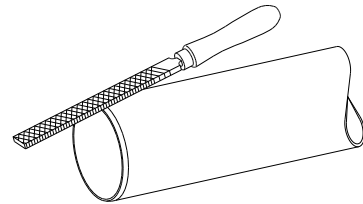

- Check all seals, sockets on pipes and fittings and pipe ends, for a distance equivalent to socket depths, are clean.
- Apply Brett Martin lubricant around the pipe end or spigot end of fittings - not around the ring seals.
- Align components and push the pipe end or fitting spigot fully into the ring seal socket to the depth of entry mark; mark the pipe or fitting spigot at the socket face.

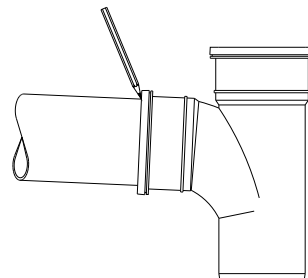

- Withdraw the pipe or spigot until the mark is 10mm away from the socket face: this creates a thermal movement allowance within the socket.

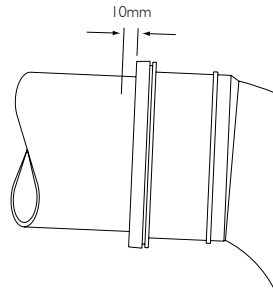

Make a subsequent check to ensure that the expansion gap is not lost during further installation work.

PERFORATED PIPE

Perforated pipes are available in 53.9mm to 400mm and are supplied in single socketed 6 metre lengths only.

Perforated pipes are normally used in French drain applications, draining rainfall from paved or concreted areas such as roads, car parks, airfields etc. The camber of the paved or concreted area runs rainfall into the permeable fill above the perforated pipe. Highway drainage systems for example usually include French drains on both sides of the carriageway and in the central reservation.

PERFORATED RIGID PIPES

INSTALLATION OF PERFORATED RIGID PIPES AS A FRENCH DRAIN

- Install Perforated Pipes as other Brett Martin pipes but use a selected permeable fill as bedding, sidefill and backfill material, Figure 34.
- Do not compact the bedfill.

FIGURE 34

FRENCH DRAIN

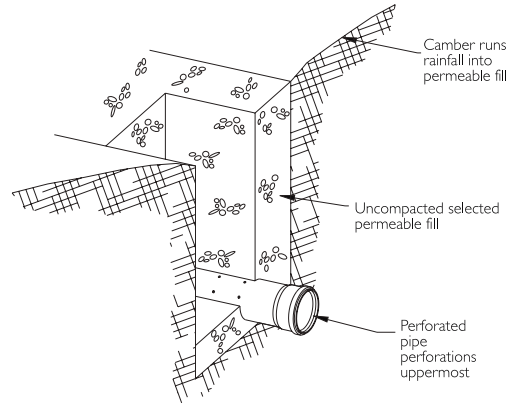

SEPTIC TANK LEACH PIPE INSTALLATION USING PERFORATED RIGID PIPES

Brett Martin Perforated Pipes may be used to dispose of septic tank effluent by sub-surface irrigation.

- Lay pipes in trenches with a uniform gradient not steeper than 1:200 from the septic tank outlet.
- Install unperforated Brett Martin pipe with a fall of 1:30 for the first 3 metres. Installing an Inspection Chamber at this point will make it easier to monitor land drainage.
- Lay the pipes on, and surround them with a 150mm layer of clinker, clean gravel or broken stone 20mm - 50mm grade. Consult the septic tank manufacturer for advice on whether to position the perforations upwards or downwards in the trench.
- Place a layer of polythene sheet over the perforated pipe before backfilling.
- Do not use pipes manufactured in accordance with BS4962 for disposing of septic tank effluent.

A herringbone pattern is commonly used (see Figure 35). A percolation test is carried out to determine the area of land needed for effluent disposal.

**FIGURE 35
SEPTIC TANK INSTALLATION SHOWING
HERRINGBONE LAYOUT OF PIPES**

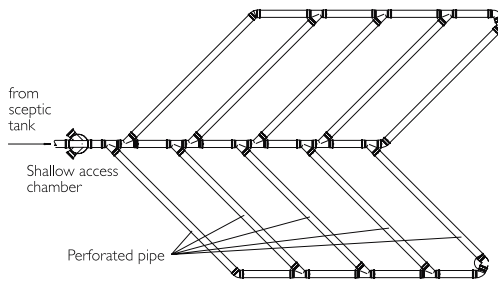

SOLVENT CEMENT JOINTING

To ensure a permanent solvent cement joint, the following procedure should be followed:

1. When a solvent joint involves a pipe, the pipe end must be cut square and all burrs and rough edges removed.
2. Clean both surfaces to be joined, making sure they are free from dirt, grease and water.
3. With a clean brush apply Brett Martin Solvent cleaner:
4. Again, with a clean brush apply Brett Martin solvent cement to both surfaces to be joined: apply the solvent cement along the surface, not around it.
5. Immediately insert the coated pipe end or fitting spigot into the coated fitting socket, using a slight twist motion to ensure correct spread of adhesive and removal of air bubbles. If cemented surfaces are left unjoined for longer than 90 seconds, bonding will not be totally effective.

6. Hold the joint still for 30 seconds for initial bonding to take place; wipe off excess solvent cement; leave for a further 2 hours to gain strength. Do not test for at least 24 hours.

Do not thin Solvent Cement or Solvent Cement Filler. As these cements are solvent based it is essential to observe the normal precautions for solvents.

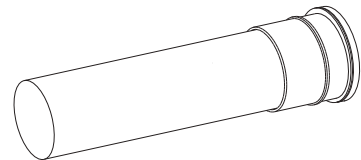
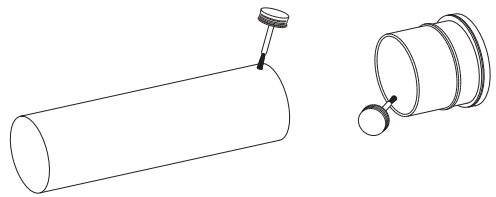

CONNECTION TO UNDERGROUND DRAINAGE

Connection to PVCu drain socket.

It is possible to connect the 110mm Soil Stack to a PVC underground drainage system: where this is of greater diameter, an adaptor must be used.

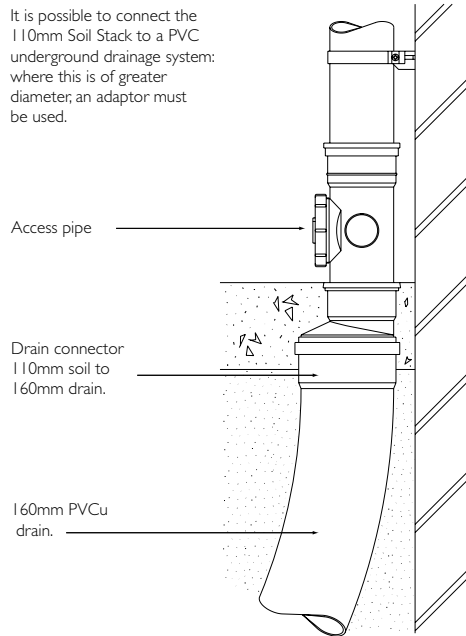

Connection to PVCu drain spigot.

With no ground floor connection, the socket should be above F.F.L. to help prevent rubbish entering the drain

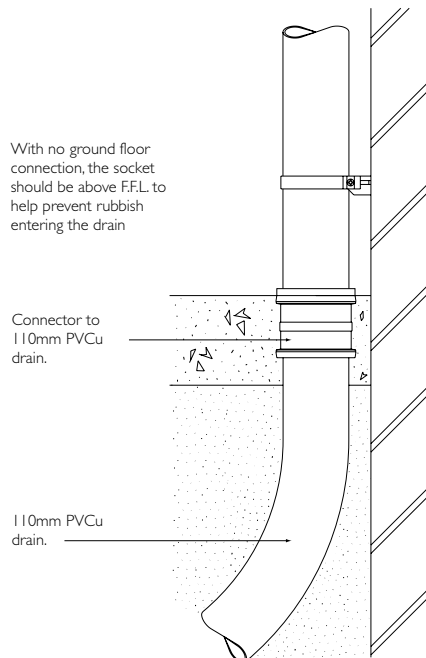

Connection to cast iron drain socket.

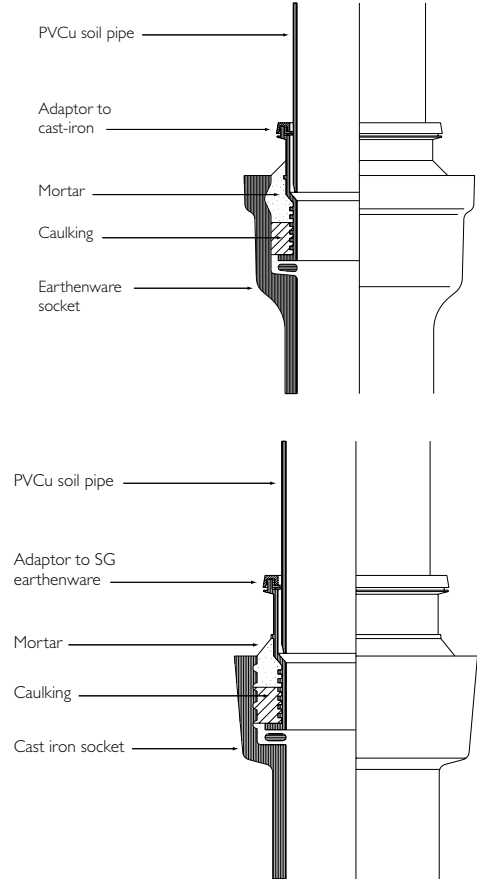

MAINTENANCE

When designed and installed correctly the Brett Martin Drain and Sewer systems are maintenance free. However, as small bore drains are more likely to block through misuse, a comprehensive range of preformed inspection chambers, shallow access chambers, access fittings and rodding eyes are available.

Before any methods of access are adopted the Local Authority must be consulted to ascertain their own specific requirements.

Conventional rods, implements and specialist power assisted equipment may be used for cleaning a PVCu drain. It is necessary to ensure that cleaning equipment, particularly the end implement, will not cause damage to the pipe and fitting walls.

Should it become necessary to repair or extend a drainage system then use of a Brett Martin Slip Coupler - Code B5001S/B7001S can be made. In diameters exceeding 160mm a range of wedged or solvent weld saddle branches are available.

CHEMICAL RESISTANCE

KEY:

+ good resistance

- poor resistance

Chemical name **Resistance**
at 23°C

Acetaldehyde 40%	+	Aniline chlorohydrate	-	Carbon monoxide	+
Acetaldehyde 100 %	-	Aniline hydrochloride	-	Carbon tetrachloride	+
Acetic acid 10%	+	Anthraquinone sulphononic acid	+	Carbonic acid	+
Acetic acid 20%	+	Antimony trichloride	+	Castor oil	+
Acetic acid 80%	+	Aqua regia	+	Caustic potash	+
Acetic acid, glacial	+	Aromatic hydrocarbons	-	Caustic soda	+
Acetic anhydride	-	Arsenic acid 80%	+	Chloroacetic acid	+
Acetone	-	Arylsulphonic acid	+	Chloral hydrate	+
Adipic acid	+	Barium carbonate	+	Choric acid 20%	+
Allyl alcohol 96%	+	Barium chloride	+	Chlorine (dry)	-
Allyl chloride	-	Barium hydroxide	+	Chlorine (wet)	-
Alum	+	Barium sulphate	+	Chlorine water	+
Aluminium alum	+	Barium sulphide	+	Chlorobenzene	-
Aluminium chloride	+	Beer	+	Chloroform	-
Aluminium fluoride	+	Beer sugar liquors	+	Chlorosulphonic acid	+
Aluminium hydroxide	+	Benzaldehyde 10%	+	Chrome alum	+
Aluminium oxychloride	+	Benzaldehyde, above 10%	-	Chromic acid 10%	+
Aluminium nitrate	+	Benzene	-	Chromic acid 50%	-
Aluminium sulphate	+	Benzine	+	Citric acid	+
Ammonia gas (dry)	+	Benzoic acid	+	Copper carbonate	+
Ammonia, liquid	-	Bismuth carbonate	+	Copper chloride	+
Ammonium acetate	+	Bleach 12% Cl	+	Copper cyanide	+
Ammonium alum	+	Borax	+	Copper fluoride	+
Ammonium bifluoride	+	Boric acid	+	Copper nitrate	+
Ammonium carbonate	+	Bromic acid	+	Copper sulphate	+
Ammonium chloride	+	Bromine liquid	-	Cottonseed oil	+
Ammonium fluoride 25%	+	Bromine water	+	Cresol	+
Ammonium hydroxide	+	Butadiene	+	Cresylic acid	-
Ammonium metaphosphate	+	Butane	+	Crotonaldehyde	-
Ammonium nitrate	+	Butanol normal	+	Crude oil	+
Ammonium persulphate	+	Butanol iso	+	Cupric fluoride	+
Ammonium phosphate	+	Butyl acetate	-	Cupric sulphate	+
Ammonium sulphate	+	Butyl phenol	+	Cuprous chloride	+
Ammonium sulphide	+	Butyric acid	+	Cyclohexanol	-
Ammonium thiocyanate	+	Cadmium cyanide	+	Cyclohexanone	-
Amyl acetate	-	Calcium bisulphite	+	Detergents	+
Amyl alcohol	+	Calcium carbonate	+	Dextrin	+
Amyl chloride	-	Calcium chlorate	+	Dextrose	+
Aniline	-	Calcium chloride	+	Diazo salts	+
		Calcium hydroxide	+	Diglycolic acid	+
		Calcium hypochlorite	+	Dimethylamine	+
		Calcium nitrate	+	Diethyl phthalate	-
		Calcium oxide	+	Disodium phosphate	+
		Calcium sulphate	+	Distilled water	+
		Carbon disulphide	-	Esters	-
		Carbon dioxide	+	Ethers	-

Ethyl acetate	-	Iodine	-	Nickel sulphate	+
Ethyl acrylate	-	Kerosene	+	Nicotine	+
Ethyl alcohol	+	Ketones	-	Nicotine acid	+
Ethyl chloride	-	Lactic acid 25%	+	Nitric acid, anhydrous	-
Ethyl ether	-	Lauric acid	+	Nitric acid 10%	+
Ethylene bromide	-	Lauryl chloride	+	Nitric acid 60%	+
Ethylene chlorohydrin	-	Lead acetate	+	Nitric acid 68%	+
Ethylene dichloride	-	Lead chloride	+	Nitrobenzene	-
Ethylene glycol	+	Lead sulphate	+	Nitrous oxide	+
Ethylene oxide	-	Lead tetraethyl	+	Oils and fats, vegetable	+
Fatty acids	+	Linoleic acid	+	Oleic acid	+
Ferric chloride	+	Linseed oil	+	Oleum	-
Ferric hydroxide	+	Lithium bromide	+	Oxalic acid	+
Ferric nitrate	+	Lubricating oil	+	Oxygen	+
Ferric sulphate	+	Machine oil	+	Ozone	+
Ferrous chloride	+	Magnesium carbonate	+	Palmitic acid	+
Fluoboric acid	+	Magnesium chloride	+	Paraffin	+
Fluorine gas (wet)	+	Magnesium citrate	+	Perchloric acid 10%	+
Fluorine gas (dry)	+	Magnesium hydroxide	+	Perchloric acid 15%	+
Fluorosillicic acid 25%	+	Magnesium nitrate	+	Perchloric acid 70%	+
Formaldehyde	+	Magnesium sulphate	+	Petrol	+
Formic acid	+	Maleic acid	+	Petrol high octane	+
Fructose	+	Malic acid	+	Phenol	+
Fruit juices and pulp	+	Mercuric chloride	+	Phenylhydrazine	-
Furfural	-	Mercuric cyanide	+	Phenylhydrazine hydrochloride	+
Gallic acid	+	Mercurous nitrate	+	Phosgene gas	+
Glucose	+	Mercury	+	Phosgene liquid	-
Glycerine	+	Methyl alcohol	+	Phosphoric acid 10%	+
Glycol	+	Methyl bromide	-	Phosphoric acid 85%	+
Glycolic acid	+	Methyl chloride	-	Phosphoric acid (yellow)	+
Heptane	+	Methyl methacrylate	-	Phosphorus pentachloride	+
Hexane	+	Methylene chloride	-	Phosphorus trichloride	-
Hexanol, tertiary	+	Methyl ethyl ketone	-	Photographic solutions	+
Hydrobromic acid 20%	+	Methyl iso butyl ketone	-	Pictic acid	-
Hydrochloric acid 10%	+	Methyl sulphate	+	Potassium alum	+
Hydrochloric acid 35%	+	Methyl sulphuric acid	+	Potassium bicarbonate	+
Hydrocyanide acid	+	Milk	+	Potassium bichromate	+
Hydrofluoric acid 50%	+	Mineral oils	+	Potassium borate	+
Hydrogen	+	Molasses	+	Potassium bromate	+
Hydrogen peroxide 30%	+	Monochloroacetic acid	+	Potassium bromide	+
Hydrogen peroxide 90%	+	Muriatic acid	+	Potassium carbonate	+
Hydrogen phosphide	+	Naphtha	+	Potassium chromate	+
Hydrogen sulphide	+	Napthalene	-	Potassium chlorate	+
Hydroquinone	+	Natural gas	+	Potassium chloride	+
Hydroxylamine sulphate	+	Nickel chloride	+	Potassium cyanide	+
Hypochlorous acid	+	Nickel nitrate	+	Potassium dichromate	+

Potassium ferricyanide	+	Sodium sulphide	+
Potassium ferrocyanide	+	Sodium sulphite	+
Potassium fluoride	+	Stannic chloride	+
Potassium hydroxide	+	Stannous chloride	+
Potassium nitrate	+	Starch	+
Potassium perborate	+	Stearic acid	+
Potassium perchlorate	+	Sulphur	+
Potassium permanganate 10%	+	Sulphur dioxide (dry)	+
Potassium permanganate 25%	+	Sulphur dioxide (wet)	+
Potassium sulphate	+	Sulphur trioxide	+
Propane liquid	+	Sulphuric acid 3%	+
Propane gas	+	Sulphuric acid 70%	+
Propargyl alcohol	+	Sulphuric acid 80%	+
Propyl alcohol	+	Sulphuric acid 85%	-
Propylene dichloride	-	Sulphurous acid	+
Plating solutions	+	Tallow	+
Rochelle salts	+	Tall oil	+
Sea water	+	Tannic acid	+
Selenic acid	+	Tartaric acid	+
Sewage	+	Tetraethyl lead	+
Sillicic acid	+	Tetrahydrofurane	-
Silver cyanide	+	Thionyl chloride	-
Silver nitrate	+	Terpineol	+
Silver plating solution	+	Titanium tetrachloride	-
Silver sulphate	+	Tanning liquors	+
Soaps	+	Toluene	-
Sodium acetate	+	Transformer oil	+
Sodium alum	+	Tributyl phosphate	-
Sodium benzoate	+	Trichlorethylene	-
Sodium bicarbonate	+	Triethanolamine	+
Sodium bisulphate	+	Trimethyl propane	+
Sodium bisulphite	+	Trisodium phosphate	+
Sodium bromide	+	Turpentine	+
Sodium carbonate	+	Urea	+
Sodium chlorate	+	Urine	+
Sodium chloride	+	Water - deionized	+
Sodium cyanide	+	Water - distilled	+
Sodium dichromate	+	Water - demineralized	+
Sodium ferricyanide	+	Water - salt	+
Sodium ferrocyanide	+	Whiskey	+
Sodium fluoride	+	Wines	+
Sodium hydroxide 10%	+	Xylene	-
Sodium hydroxide 50%	+	Yeast	+
Sodium hypochlorite	+	Zinc chloride	+
Sodium nitrate	+	Zinc nitrate	+
Sodium peroxide	+	Zinc sulphate	+
Sodium sulphate	+		



Plumbing & Drainage

Ireland

24 Roughfort Road
Mallusk, Co. Antrim
Northern Ireland, BT36 4RB
Tel: 028 9084 9999
Fax: 028 9083 6666
Trade Counter: 028 9084 8999
Email: sales@brettmartin.com

England & Wales

Speedwell Ind. Estate
Staveley, Derbyshire
England, S43 3JP
Tel: 01246 280000
Fax: 01246 280001
Email: building@brettmartin.com

100 Camford Way
Sundon Park
Luton, Bedfordshire
England, LU3 3AN
Tel: 01246 280000
Fax: 01246 280001

Scotland

Blairlinn Road
Cumbernauld, Glasgow
Scotland, G67 2TF
Tel: 01---5536
Fax: 01236 725871
Email: scotland@brettmartin.com

For the latest information
visit the company's website:

www.brettmartin.com



All reasonable care has been taken in the compilation of the information contained within this literature. All recommendations on the use of our products are made without guarantee as conditions of use are beyond the control of Brett Martin. It is the customer's responsibility to ensure that each product is fit for its intended purpose and that the actual conditions of use are suitable.

Brett Martin pursues a policy of continuous product development and reserves the right to amend specifications without prior notice.

Copyright Brett Martin Ltd